

STANLEY[®]
Access Technologies

PERFORMANCE IN ACTION™



ICU/CCU Doors You Can Depend On



WITH OVER
87
YEARS OF EXPERIENCE
AND DEDICATION

THE STANLEY DIFFERENCE

We are reliable to our core because you depend on us.

Even though we already have the largest geographic footprint in North America, we are continuously expanding our team of R&D and innovation engineers, sales representatives and service and install technicians. This paired with being the only manufacturer with 2 US factories means you can trust us to get what you need, how you need it and when you need it.

We never cut corners when it comes to safety and conformance.

Excellence is equated to making it right the first time, because we know every expertly crafted product we make needs to help you do better, safer, more significant work. Our unwavering mission to adhere to the highest standards of material, workmanship and service since we invented the first swinging automatic door over 80 years ago is the reason we continue to be the industry leader.

Experience and dedication to take you from where you are to where you want to go.

Our job is to help you do yours better, and we take pride in what you make possible. So you get consistency that meets your complete satisfaction, our products are only sold by, shipped by, handled by and installed by dedicated STANLEY employees and partners. Their experience with product solutions, codes and standards, and the industry runs deep; with an average of 12 years for our technicians and 13 years for our sales representatives.

We are a Purpose-driven organization. This is what binds us and drives us to do the impossible. **Together, we can Make The World Accessible.**

DOOR SERVICE MADE SIMPLE

DOORS ARE NOT YOUR MOST CRITICAL PIECE OF HEALTHCARE EQUIPMENT. BUT WE BUILD THEM AS IF THEY WERE.

As a service customer, you will receive the expertise of the industry's largest and most experienced automatic door service provider in North America. You can be assured your equipment is kept in top operating condition, planned maintenance is completed as required, parts replacement meet manufacturer's specification, and all activity is appropriately documented thereby minimizing your liability exposure.

For more information visit
stanleyaccess.com/service-support

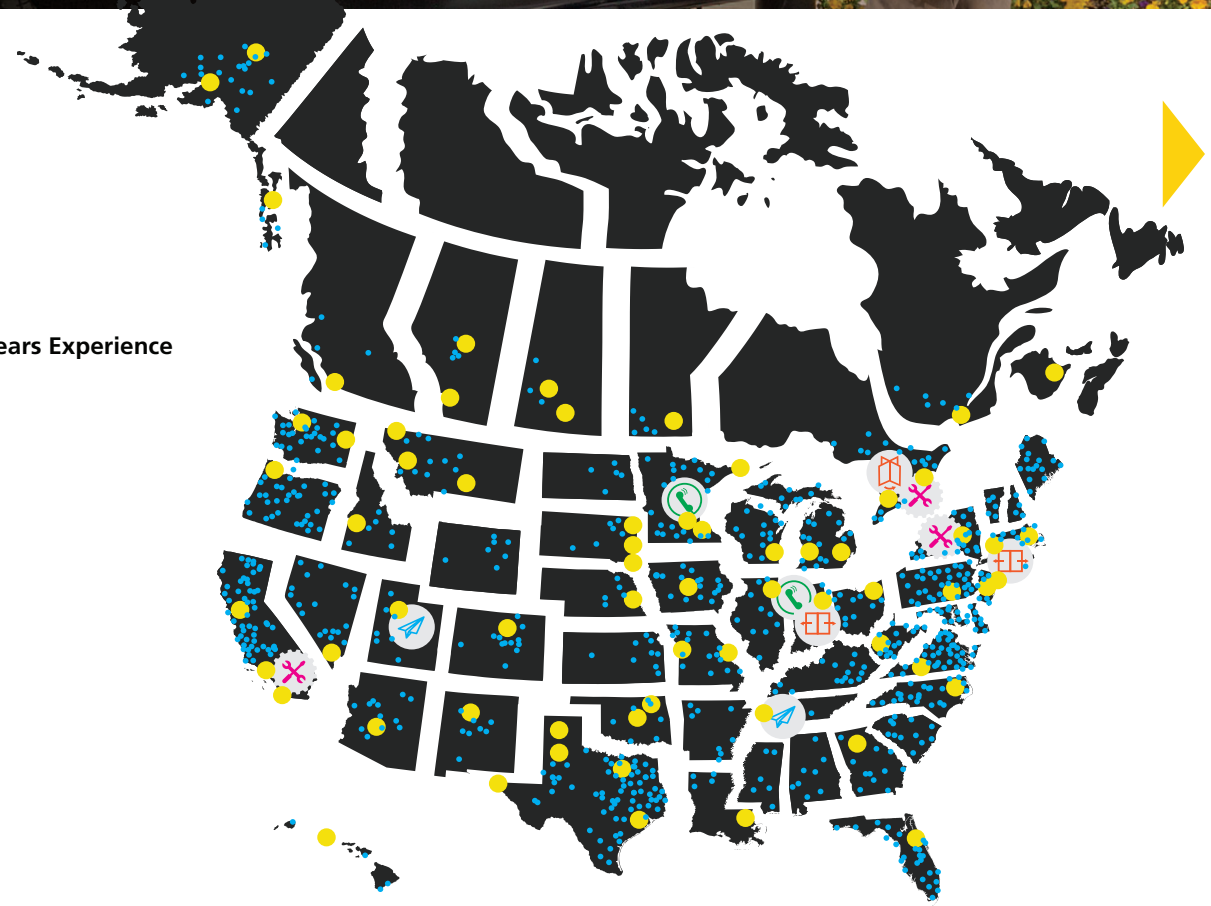

- 83 Central Locations
- 750+ Technicians With an Average of 12 Years Experience
- ✂ 3 Rebuild Centers
- ☎ 2 Centralized Service Call Centers
- 🏢 3 ISO Certified Manufacturing Facilities
- ✈ 2 Regional Distribution Centers

INTERACTIVE Table of Contents

PRODUCT FEATURE COMPARISON CHART 06

AUTOMATIC AND MANUAL SLIDING TRACKLESS

- › ProCare Difference 07
- › 2-Panel Manual 08
- › Compact 4-Panel Manual Bi-Part 09
- › 3-Panel Manual Telescoping 11
- › 2-Panel and 3-Panel Automatic 13
- › P-Panel Options 14

MANUAL SWING AND HYBRID SWING-FOLD 16

PRODUCT FEATURE COMPARISON CHART

ICU DOOR PRODUCT FEATURES	SLIDING									SWINGING	
	ProCare 8300	ProCare 8300A	ProCare 8300BP	Dura-Care 7000TL	Dura-Care 7200	Dura-Care 7300TL-FBO	Dura-Care 7500A	Dura-Care 7500TL	Dura-Care 7500TL-FBO	Dura-Care 7400	Dura-Care 7600
Rough Opening Range	84.5"-108.5"	84.5"-108.5"	84.5"-144.5"	92.5"-104.5"	84.5"-108.5"	84.5"-108.5"	84.5"-108.5"	84.5"-108.5"	84.5"-108.5"	76"-100" (Pair)	84.5"-120.5"
Largest Clear Door Walk-Thru Opening ^[2]	50.2"	49.3"	65"	43.4"	47.3"	50.2"	60.6"	60.6"	55.5"	91.5" (Pair)	99.8"
Trackless Threshold	✓	✓	✓	✓	✓	✓	✓	✓	✓	✓	✓
Break Out Panels	All Panels	All Panels	All Panels	All Panels	Only Sliding	All Panels	All Panels	Only Lead Sliding	All Panels	All Panels	All Panels
Panel Design Options	2-Panel	2-Panel	4-Panel	2-Panel	2-, 4- & P-Panel	2-Panel	3-Panel	3-, 6- & P-Panel	3- & 6-Panel	Single, Pair & Uneven Pair	3-Panel
Synchronized Panels			✓				✓	✓			
Automatic Operation		✓					✓				
Smoke & Draft Rated (UL 1784) Option	✓	✓	✓	✓	2-Panel	✓		3-Panel	3-Panel	✓	
2010 FGI Airborne Isolation Infection Room (Closer Required)	✓	✓	✓			✓				✓	
Positive/Negative Pressure for Isolation Rooms	✓	✓	✓		2-Panel	✓				✓	
STC Rated ^[1]	✓										
New Catchless Handle	✓	✓	✓								
New Positive Latch Hook Shield	✓	✓	✓								
Optional Positive Latching	✓	✓	✓	✓	✓	✓	✓*	✓	✓	✓	
Electronic Privacy Glass Option		✓		✓	✓			✓	✓		
Integral Blinds Option	✓	✓	✓	✓	✓	✓	✓	✓	✓	✓	✓
	Visit Webpage	Visit Webpage	Visit Webpage	Visit Webpage	Visit Webpage	Visit Webpage	Visit Webpage	Visit Webpage	Visit Webpage	Visit Webpage	Visit Webpage

¹ Requires recommended STC rated glass

² Without positive latch

*Electric Solenoid Lock

DISCLAIMER: These charts are to illustrate standard versions of our most popular products; for customized options and sizes, or additional panel configurations other than those shown please contact an authorized STANLEY representative.

THE PROCARE DIFFERENCE

The industry's only human-centric ICU doors deliberately designed with respect for patients and caregivers in sensitive healthcare environments.



Protect the Patient



Eliminate dangerous snagging of IV lines and equipment during patient transport.

Wide clear door opening including the widest of any 2-panel in the industry.

Promote Healing



Easy and more controlled breakaway and return with our new instant swing out button.

Quiet and flawless operation every time with our swing out guidance system.

Ask A Question

PROCARE 8300 Manual Slide Trackless 2-Panel



STANDARD FEATURES
 Swing Out Button (STANLEY Exclusive)
 Swing Out Guidance System (STANLEY Exclusive)
 Catch Free Contoured Handle (STANLEY Exclusive)
**FOR INFORMATION, VALUE ENGINEERED OPTIONS,
 SPECS AND DRAWINGS GO TO**
stanleyaccess.com/procare-8300

Watch The Video

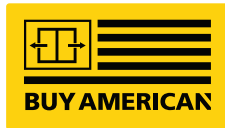
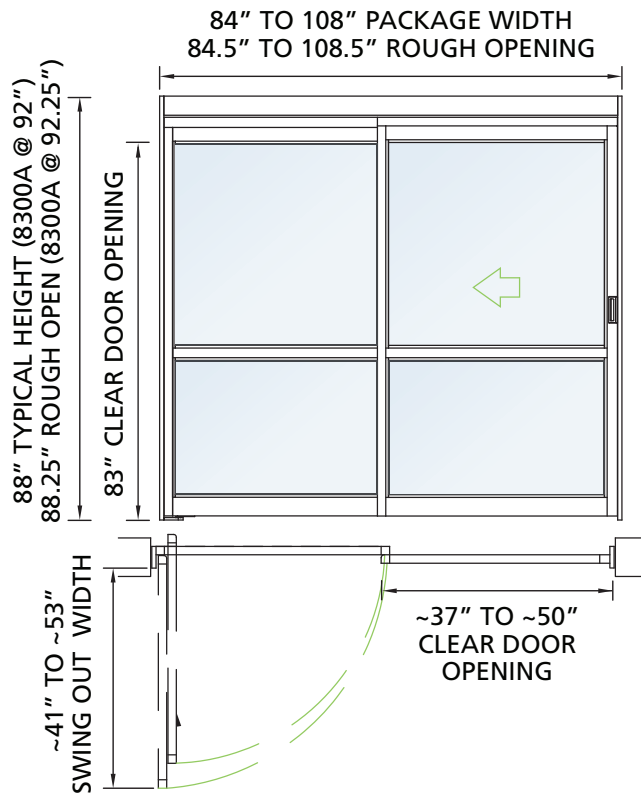

*The typical ProCare 8300 Manual model complies with the Buy American Act, as specified in Section 52.225-1 and Section 52.225.11 of the Federal Acquisition Regulations as of August, 2017.

Note: Clear door opening is measured without positive latch

SOLUTIONS FOR

- › Rough Opening Width Range: ~84.5" - 108.5"
- › Clear Door Opening Width Range: ~38" - 50"
- › Patient Privacy
- › Frequent Swing Out and Reset

APPLICATIONS

- › ICU/CCUs
- › Pressurized Isolation Rooms
- › Smoke Rated Rooms
- › Emergency Department Treatment Rooms
- › Pre/Post Surgery Rooms
- › Same Day Surgery Rooms
- › Trauma Rooms
- › Hospital Pharmacies
- › Operating Rooms
- › Corridors



Manual Compact 4-Panel Bi-Part

SOLUTIONS FOR

- › Compact Panels Allow for Corridor Breakout
- › Rough Opening Width Range: 84.5" - 144.5"
- › Patient Privacy
- › Large View Area
- › Large Clear Door for Patient Transfer

APPLICATIONS

- › ICU/CCUs
- › Pressurized Isolation Rooms
- › Emergency Department Treatment Rooms
- › Pre/Post Surgery Rooms
- › Same Day Surgery Rooms
- › Trauma Rooms
- › Office/Meeting Rooms

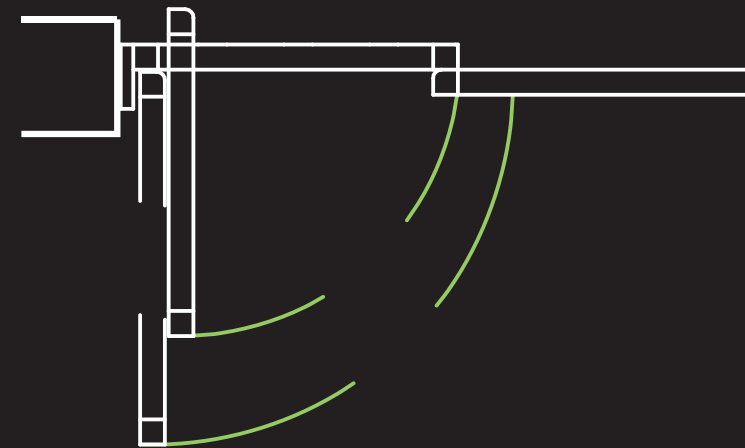
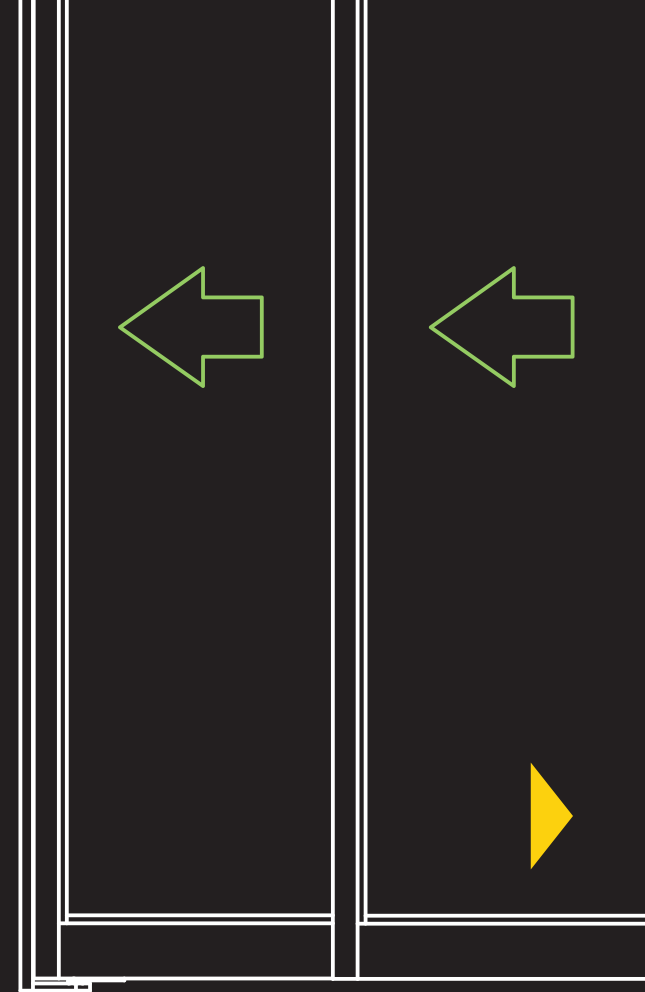

PROCARE 8300 BP Manual Compact 4-Panel Bi-Part

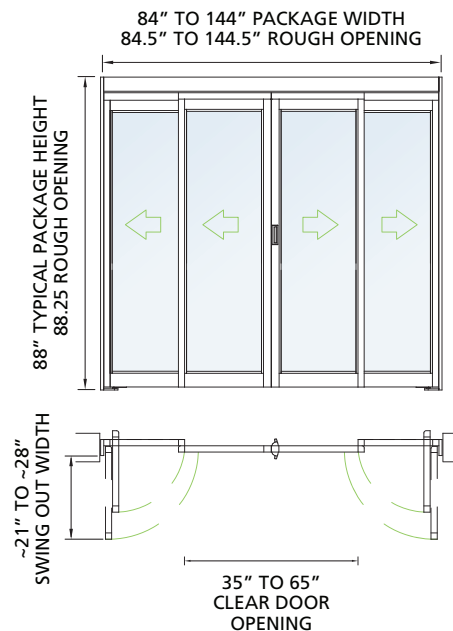

RATINGS*:
Smoke & Draft
Infection control

MORE INFORMATION
[stanleyaccess.com/
procare-8300bp](http://stanleyaccess.com/procare-8300bp)

Watch The Video



The **space-optimizing ICU door solution**, this compact 4-panel bi-part is the newest alternative to the standard ICU door. With a smaller breakaway arc, you can meet NFPA corridor codes and **never have to give up a square inch of your patient room design**. Effortless **one-handed operation** slides both center panels simultaneously. Our exclusive soft open/close **prevents loud slamming** and extends the life of the door.

STANDARD FEATURES

- Swing Out Button (STANLEY Exclusive)
- Swing Out Guidance System (STANLEY Exclusive)
- Catch Free Contoured Handle (STANLEY Exclusive)
- Soft Open / Close (STANLEY Exclusive)

* Restrictions may apply such as overall frame height, sliding/breakaway panel width and glazing.
Note: Clear door opening is measured without positive latch

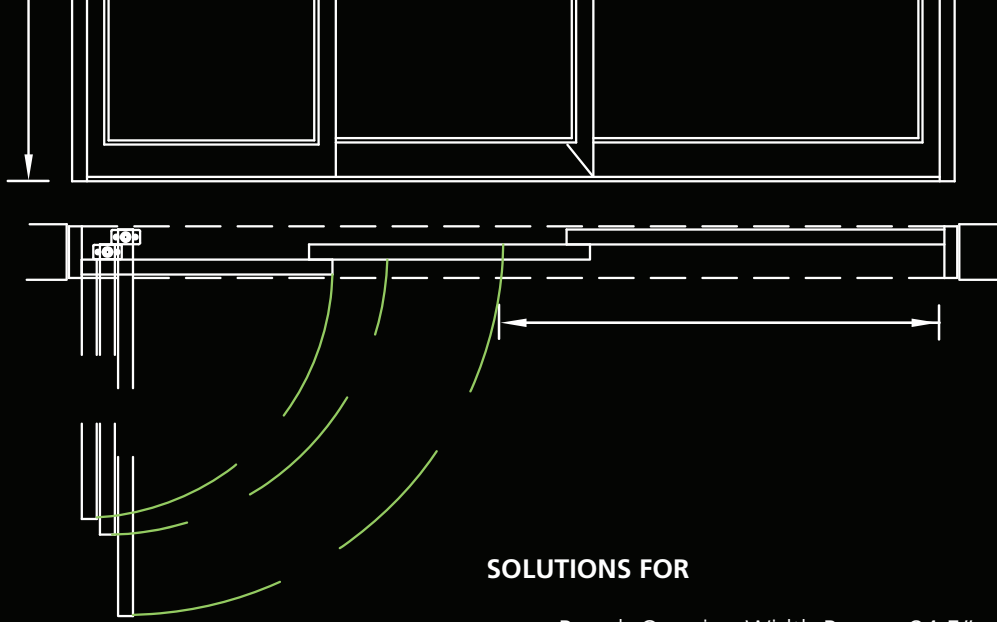

SOLUTIONS FOR

- › Rough Opening Width Range: 84.5" - 108.5"
- › Clear Door Opening Width Range: 39.5" - 55.5"
- › Largest Clear Door Opening Vs Rough Opening
- › Patient Privacy
- › Low Swing Out Volume
- › Small Patient Rooms/Corridors: Shorter Swinging Panels

APPLICATIONS

- › ICU/CCUs
- › Pressurized Isolation Rooms
- › Smoke Rated Rooms
- › Emergency Department Treatment Rooms
- › Pre/Post Surgery Rooms
- › Same Day Surgery Rooms
- › Trauma Rooms
- › Large Office/Meeting Rooms
- › Bariatric Treatment Rooms

Manual
Telescoping
Trackless
3-Panel

DURA-CARE 7500 TL-FBO Manual Telescoping Trackless 3-Panel

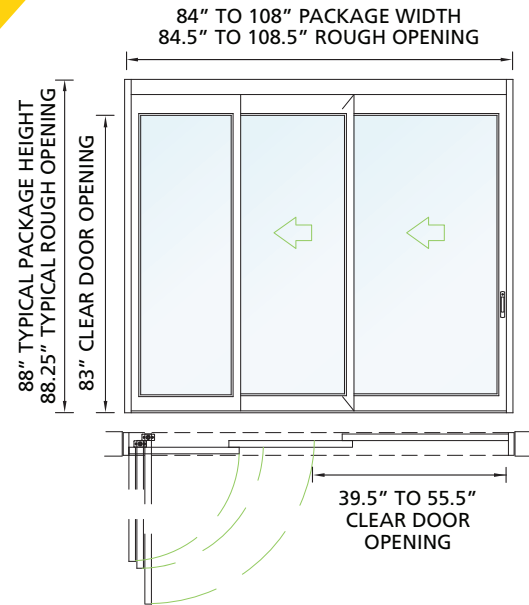

AVAILABLE IN: 6-panel bi-part and tracked versions

STANDARD FEATURES
Recessed Handle
Swing Out Lever

RATINGS*: Smoke & Draft

MORE INFORMATION:
stanleyaccess.com/duracare-7500series

Bone & Joint Institute,
Hartford, CT
Perkins and Will Architects



* Restrictions may apply such as overall frame height, sliding/breakaway panel width and glazing. Note: Clear door opening is measured without positive latch

ProCare 8300A Automatic 2-Panel Single Slide

2-panel automatic sliding door. Jamb mounted touch-less wave activation and overhead safety sensors. Newly designed to protect patients with safer transfers and promote healing by eliminating disruptions.

RATINGS*: ANSI/BHMA A156.10 (Typical)
Option: Low Energy ANSI/BHMA A156.38

MORE INFORMATION: stanleyaccess.com/procare-8300a

Watch The Video



SOLUTIONS FOR

- › Infection Control
- › Patient Privacy
- › Frequent Breakaway for Patient Transport

APPLICATIONS

- › ICU/CCUs
- › Pressurized Isolation Rooms
- › Smoke Rated Rooms
- › Emergency Department Treatment Rooms
- › Pre/Post Surgery Rooms
- › Same Day Surgery Rooms
- › Trauma Rooms
- › Hospital Pharmacies
- › Operating Rooms

Dura-Care 7500A Automatic 3-Panel Telescoping

3-panel automatic sliding door. Jamb mounted touch-less wave activation and overhead safety sensors.

MORE INFORMATION:
stanleyaccess.com/duracare-7500Series

* Restrictions may apply such as overall frame height, sliding/breakaway panel width and glazing.

P-Panel/Surface Applied

Trackless 2-, 3-, 4- and 6-Panel Manual

SOLUTIONS FOR

- › Rough Opening Width Range: 35.3" x 106.3"
- › Clear Door Opening Width Range: 35.3" - 91.5"
- › Retrofit

APPLICATIONS

- › Renovations
- › Patient Bathrooms
- › ICU/CCUs
- › Pressurized Isolation Rooms
- › Emergency Department Treatment Rooms
- › Pre/Post Surgery Rooms
- › Same Day Surgery Rooms
- › Trauma Rooms
- › Office/Meeting Rooms

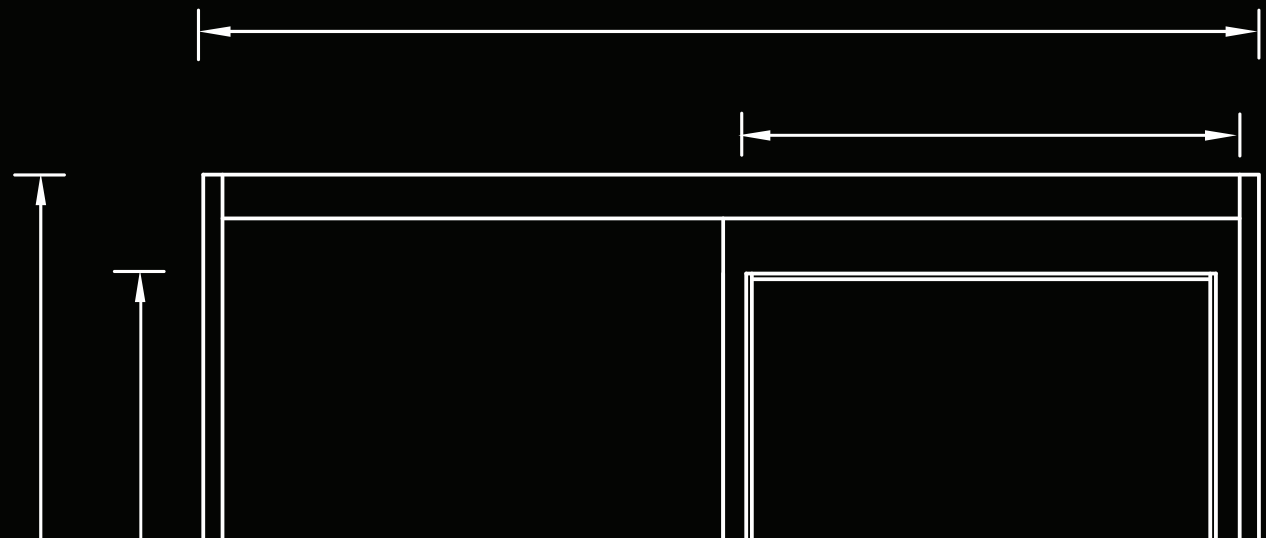

Ask A Question

Dura-Care 7200 Manual 2-Panel Single Slide

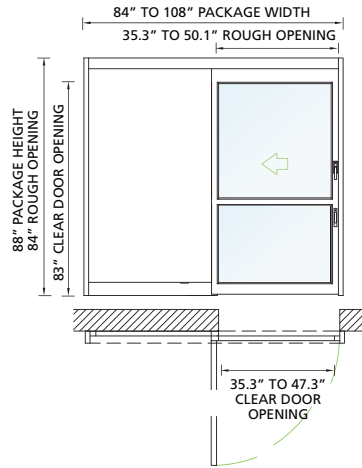

RATINGS*:
 Customized Base Model
 Smoke & Draft
 Infection Control (+/- Pressure)

MORE INFORMATION:
stanleyaccess.com/dura-care-7200-manual-door

AVAILABLE IN: 4-panel model



Dura-Care 7200
 with Privacy Glass
 St. Michael's,
 Toronto, Canada
 NORR Architects

Dura-Care 7500TL 3-Panel Manual 3-Panel Telescoping

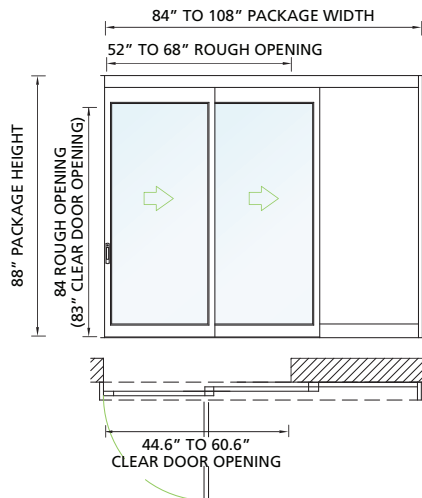

MORE INFORMATION:
stanleyaccess.com/duracare-7500Series

AVAILABLE IN: 6-panel model



* Restrictions may apply such as overall frame height, sliding/breakaway panel width and glazing.
 Note: Clear door opening is measured without positive latch

Dura-Care 7400 Manual Swing

STANDARD FEATURE:
Positive latching standard

RATINGS*: Smoke and Draft

MORE INFORMATION:
stanleyaccess.com/manual-icu-ccu-swing

SOLUTIONS FOR

- › Rough Opening Width Range: ~84" - 108"
- › Clear Door Opening** Width Range: ~33" - 50"
- › Patient Privacy
- › Frequent Swing Out and Reset
- › Infection Control

APPLICATIONS

- › ICU/CCUs
- › Pressurized Isolation Rooms
- › Smoke Rated Rooms
- › Emergency Department Treatment Rooms
- › Pre/Post Surgery Rooms
- › Same Day Surgery Rooms
- › Trauma Rooms
- › Hospital Pharmacies
- › Operating Rooms
- › Corridors



Uneven Pair

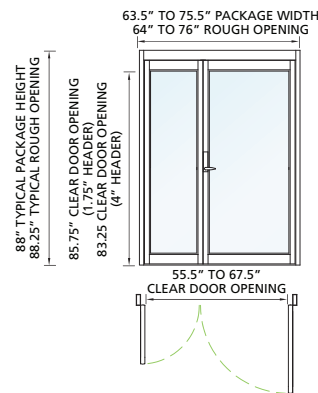

Pair

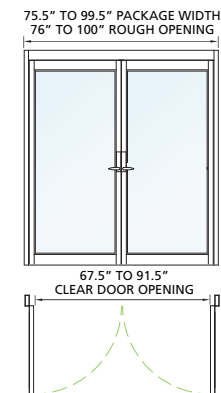

Single



* Restrictions may apply such as overall frame height, sliding/breakaway panel width and glazing.

** Clear door opening is measured without positive latch

Dura-Care 7600 Manual Hybrid Swing-Fold

OPTIONS:

Integral Blinds on Swing Leaf Self-Closing On Active Panel, 1-Point Locking

MORE INFORMATION:

stanleyaccess.com/hybrid-swing-fold

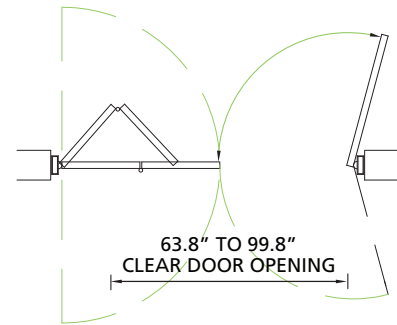
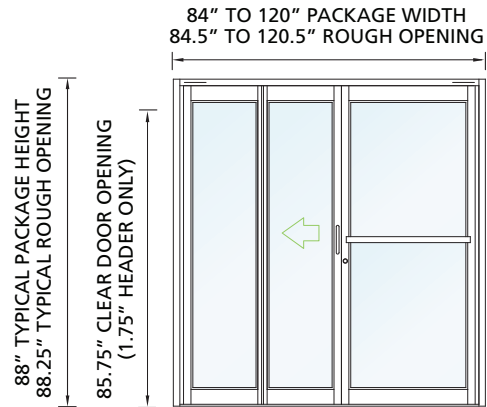

SOLUTIONS FOR

- › Rough Opening Width Range: 85.5" x 120.5"
- › Clear Door Opening* Width Range: 63.8" - 99.8"
- › Versatile Space Needs

APPLICATIONS

- › ICU/CCUs
- › Pressurized Isolation Rooms
- › Emergency Department Treatment Rooms
- › Pre/Post Surgery Rooms
- › Same Day Surgery Rooms
- › Trauma Rooms

Combines a bi-directional manual swing door with a two-panel manual bi-fold door in one continuous header. The swing panel comes with a door closer but will hold open when pushed past 105-degrees. The bi-fold panels can either fold in or fold out and can fully (swing open) breakout) when more space is needed.

** Clear door opening is measured without positive latch

STANLEY®

Access Technologies

CONTACT

StanleyAccess.com

1-800-7-ACCESS

Service: 1-888-DOOR-444

QUICK LINKS

[Submit Questions](#)

[Contact The Rep Closest To Your Job Site Service](#)



MAKE THE

WORLD

ACCESSIBLE