

STANLEY[®]
Access Technologies

PERFORMANCE IN ACTION™



Evolving Doors for Advancing Healthcare

◀◀ Bone & Joint
Institute
Hartford, CT
Architects: HDR and
Perkins + Will



WITH OVER
87
YEARS OF EXPERIENCE
AND DEDICATION

THE STANLEY DIFFERENCE

We are reliable to our core because you depend on us.

Even though we already have the largest geographic footprint in North America, we are continuously expanding our team of R&D and innovation engineers, sales representatives and service and install technicians. This paired with being the only manufacturer with 2 US factories means you can trust us to get what you need, how you need it and when you need it.

We never cut corners when it comes to safety and conformance.

Excellence is equated to making it right the first time, because we know every expertly crafted product we make needs to help you do better, safer, more significant work. Our unwavering mission to adhere to the highest standards of material, workmanship and service since we invented the first swinging automatic door over 80 years ago is the reason we continue to be the industry leader.

Experience and dedication to take you from where you are to where you want to go.

Our job is to help you do yours better, and we take pride in what you make possible. So you get consistency that meets your complete satisfaction, our products are only sold by, shipped by, handled by and installed by dedicated STANLEY employees and partners. Their experience with product solutions, codes and standards, and the industry runs deep; with an average of 12 years for our technicians and 13 years for our sales representatives.

We are a Purpose-driven organization. This is what binds us and drives us to do the impossible. **Together, we can Make The World Accessible.**



DOOR SERVICE MADE SIMPLE

DOORS ARE NOT YOUR MOST CRITICAL PIECE OF HEALTHCARE EQUIPMENT. BUT WE SERVICE THEM AS IF THEY WERE.

As a service customer, you will receive the expertise of the industry's largest and most experienced automatic door service provider in North America. You can be assured your equipment is kept in top operating condition, planned maintenance is completed as required, parts replacement meet manufacturer's specification, and all activity is appropriately documented thereby minimizing your liability exposure.

For more information visit
stanleyaccess.com/service-support



-  83 Central Locations
-  750+ Technicians With an Average of 12 Years Experience
-  3 Rebuild Centers
-  2 Centralized Service Call Centers
-  3 ISO Certified Manufacturing Facilities
-  2 Regional Distribution Centers

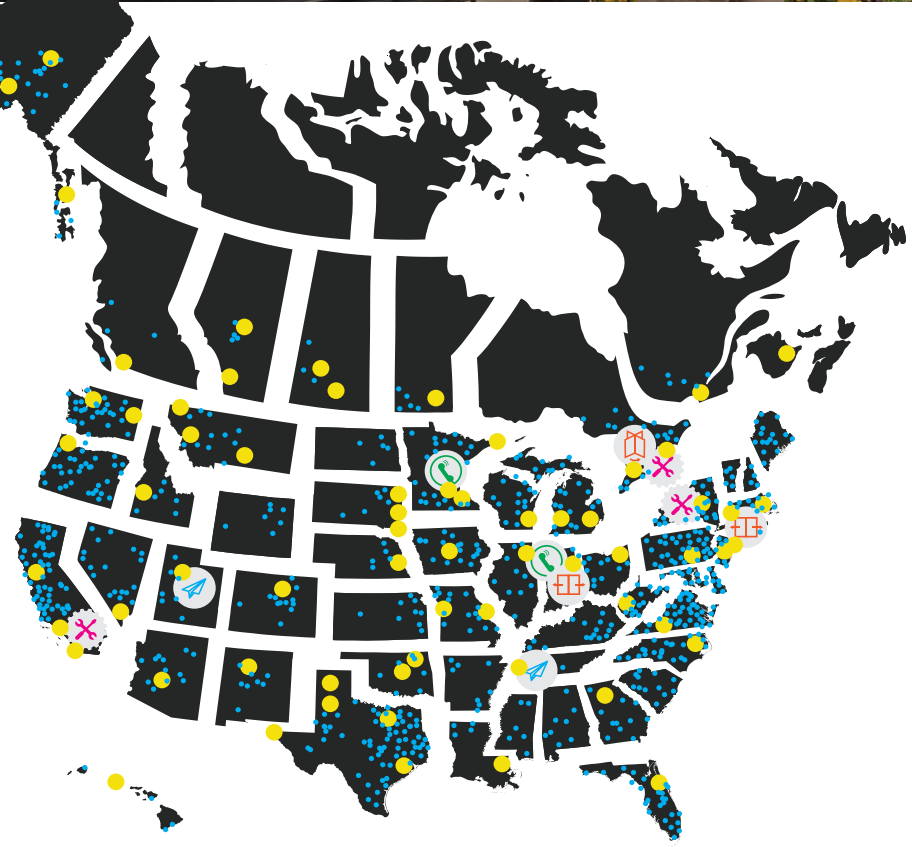

Table of Contents

Product Feature Comparison	
› Patient Room and ICU Doors	04
› Sliding Automatic Doors	05
› Revolving Doors	05
Applications	
› Exterior	06
› Interior	14
Product Type	
› Automatic Sliding Doors	07-11, 20
› Automatic Swing Doors	13, 19
› Automatic Revolving Doors	12
› Manual & Automatic Sliding ICU Doors	15-18
› Manual Swing and Swing/Fold Doors	19

SELECTION GUIDE

Product Features

ICU DOOR PRODUCT FEATURES	SLIDING					SWINGING	
	ProCare 8300	ProCare 8300A	ProCare 8300BP	Dura-Care 7500A	Dura-Care 7500TL-FBO	Dura-Care 7400	Dura-Care 7600
Rough Opening Range	84.5"-108.5"	84.5"-108.5"	84.5"-144.5"	84.5"-108.5"	84.5"-108.5"	76"-100" (Pair)	84.5"-120.5"
Largest Clear Door Walk-Thru Opening ²⁾	50.2"	49.3"	65"	60.6"	55.5"	91.5" (Pair)	99.8"
Trackless Threshold	✓	✓	✓	✓	✓	✓	✓
Break Out Panels	All Panels	All Panels	All Panels	All Panels	All Panels	All Panels	All Panels
Panel Design Options	2-Panel	2-Panel	4-Panel	3-Panel	3-, & 6-Panel	Single, Pair & Uneven Pair	3-Panel
Synchronized Panels			✓	✓			
Automatic Operation		✓		✓			
Smoke & Draft Rated (UL 1784) Option	✓	✓	✓		3-Panel	✓	
2010 FGI Airborne Isolation Infection Room (Closer Required)	✓	✓	✓			✓	
Positive/Negative Pressure for Isolation Rooms	✓	✓	✓			✓	
STC Rated	✓	✓	✓				
New Catchless Handle	✓	✓	✓				
New Positive Latch Hook Shield	✓	✓	✓				
Optional Positive Latching	✓	✓	✓	✓ [*]	✓	✓	
Electronic Privacy Glass Option		✓			✓		
Integral Blinds Option	✓	✓	✓	✓	✓	✓	✓
	Visit Webpage	Visit Webpage	Visit Webpage	Visit Webpage	Visit Webpage	Visit Webpage	Visit Webpage

¹ Requires recommended STC rated glass

² Without positive latch

^{*} Electric Solenoid Lock

DISCLAIMER: These charts are to illustrate standard versions of our most popular products; for customized options and sizes, or additional panel configurations other than those shown please contact an authorized STANLEY representative.

Sliding Automatic Doors



Features	Dura-Glide						Dual Enter/Exit	Hurricane Rated	Enhanced Security	Telescoping	Operator Only				
	2000	3000	All Glass 2000	All Glass 3000	GreenStar 2000	GreenStar 3000	ByPass	Dura-Storm 2000 (I, NI)	Dura-Storm 3000 (I, NI)	Dura-Shield Ballistic	Dura-Shield Blast	DuraFit™	Telescopic 5200	Telescopic 5300	Slim Line Header
Retrofit Ready	•	•	•	•	•	•	•	•	•	•	•	•	•	•	•
Surface Mounted	•	• ¹		• ¹	•	• ¹				•	• ¹	•	•	• ¹	•
Concealed	•	•	•	•	•	•	•	•	•	•	•	•	•	•	
Single Slide	•	•	•	•	•	•	•	•	•	•	•		•	•	•
Bi-part	•	•	•	•	•	•	N/A	•	•	•	•	•	•	•	•
Non-Breakout											•				•
Fixed Sidelight	•		•		•		•	•		•			•		
Full Breakout		•		•		•	•		•			•		•	
Access Control Option (Solenoid Lock)	•	•	•	•	•	•	•	•	•	•	•	•	•	•	•
Access Control Option (Panic Hardware and Solenoid Lock)	•	•			•	•	•					•	•	•	
Extra Heavy Duty Construction							•	•	•	•					
Code Compliance															
Clean Room Certified	•	•											•	•	
Wind Pressure Rated (Hurricane)							•	•							
Impact Rated (Hurricane)							(I)	(I)							
ASHRAE 90.1 (Air Leakage)					•	•	•	•							
IECC (U, SHGC)					• ²	• ²									

Revolvers



Features	500	1500 Manual	1500 Automatic	2500 Manual	3500 Manual	4500 Manual Security	4900 ASR Automatic Security
All Glass Version Available				•	•		
Three Wing		•	•	•	•	•	
Four Wing	•	•		•	•	•	•

I - Impact

1 Consult you local STANLEY representative for appropriate parameters

2 Configuration and glazing dependent

DISCLAIMER: These charts are to illustrate a standard product package; for customized options and sizes other than those shown please contact an authorized STANLEY representative.

EXTERIOR



AUTOMATIC SLIDING DOORS



- ▶▶ **2000 Designer Package** Epoch Senior Living & National Development. Mahogany wood doors and cladding. Architect: Elkus Manfredi | GC: Cranshaw Construction



- ▶▶ University of Wisconsin Cancer Center

STANDARD MODEL: Dura-Glide

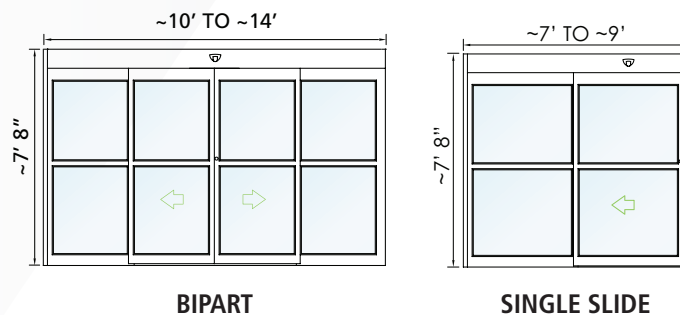

DIFFERENTIATION: The number one selling automatic door in North America. Highest horsepower motor in the industry, header crafted with high strength aluminum to prevent sagging. All components fully tested and pre-assembled at factory for fast, trouble-free installation.

AVAILABLE IN: Full breakaway and partial breakaway, Eco-friendly GreenStar, and operator only.

CLEAR DOOR OPENING: Bipart: 48.3" - 72.3" | Single Slide: 35.3" - 47.3"

MORE INFORMATION:

stanleyaccess.com/dura-glide

stanleyaccess.com/dg-greenstar

stanleyaccess.com/slide-door-operators



ALL GLASS: Dura-Glide

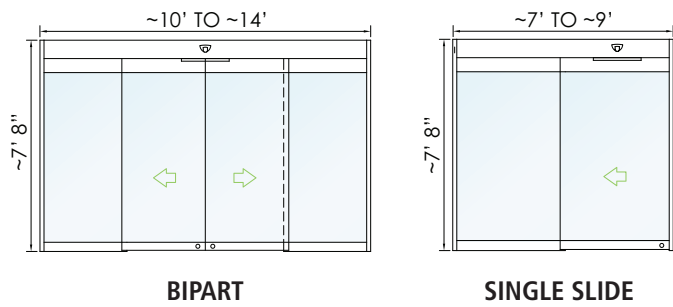

DIFFERENTIATION: The beauty of an all glass door with the durability of a Dura-Glide. Integrated glass clamp hangers and pre-assembled header for fast and trouble-free installation.

CLEAR DOOR OPENING: Bipart: 48.3" - 72.3" | Single Slide: 35.3" - 47.3"

MORE INFORMATION:
stanleyaccess.com/all-glass

LEVEL D AND LEVEL E HURRICANE RATED: DURA-STORM

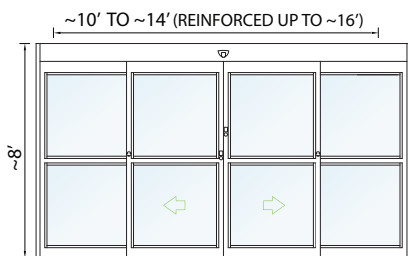

BIPART

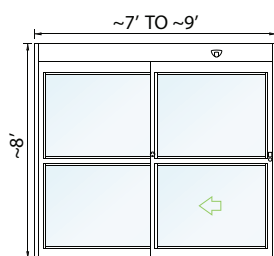

SINGLE SLIDE



DIFFERENTIATION: Meets the most stringent building requirements for hurricane force winds and flying debris.

CLEAR DOOR OPENING:
Bipart 70.6" | Single Slide: 46.4"

APPLICATIONS: Enhanced security for buildings that need to withstand high wind pressure. Areas that lack hurricane codes can benefit by improving building integrity.

MORE INFORMATION: stanleyaccess.com/dura-storm

AVAILABLE IN THE FOLLOWING CONFIGURATIONS:
Florida Building Code compliance, Miami-Dade County NOA Code Compliance and ASTM E283, and Level E hurricane rated.

CLEAR DOOR OPENING: Bipart 70.6" | Single Slide: 46.4"

BLAST OR BALLISTIC RATED: DURA-SHIELD*



BIPART

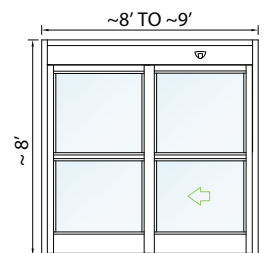

SINGLE SLIDE



DIFFERENTIATION: Ballistic version provides protection from Level 3 ballistic (projectiles in flight) attacks. Complies with UL 752 (Standard for Bullet Resisting Equipment). Complies with all facets of ANSI 156.10 except emergency egress breakaway.

CLEAR DOOR OPENING: Bipart: 68 5/8"
Single Slide 36 1/16" to 42 1/16"

APPLICATIONS: Enhanced security for buildings where sliding automatic entrances are required to protect high-risk areas such as Emergency Rooms.

MORE INFORMATION:
stanleyaccess.com/blast-resistant
stanleyaccess.com/ballistic-resistant

* Contact STANLEY product experts prior to specifying



TELESCOPING 5200/5300

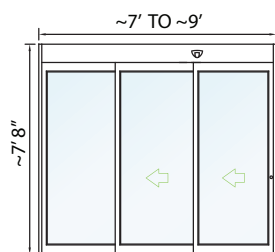

3-PANEL

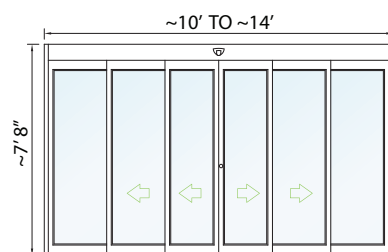

BIPART 6-PANEL

DIFFERENTIATION: Larger clear door opening than a single slide or bipart sliding door. Synchronized moving panels.

CLEAR DOOR OPENING: 3-Panel 44.56" to 60.56" | 6-Panel: 59-9/16" to 91-9/16"

MORE INFORMATION:

stanleyaccess.com/telescopic-5200-5300



DURAFIT™

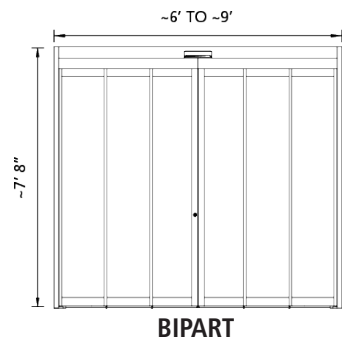

Differentiation: Synchronized overlapping panels provide the largest possible walkthrough for small 6ft-9ft rough openings allowing gurneys and wheelchairs to pass through comfortably, accommodating two-way traffic. Reinforced construction and long-lasting wearable parts can withstand repeated impact with medical equipment.

Clear Door Opening: 43.8" - 68.2" providing one of the widest clear door opening per rough opening in the industry.

More information: stanleyaccess.com/durafit

AUTOMATIC REVOLVING DOORS

AUTOMATIC THREE-WING REVOLVING DOOR: STANLEY RUSH 1500A



DIFFERENTIATION: Various canopy heights (over 12") are available to suit any design requirement. Available in 10' - 12' diameters.

MORE INFORMATION: stanleyaccess.com/1500a

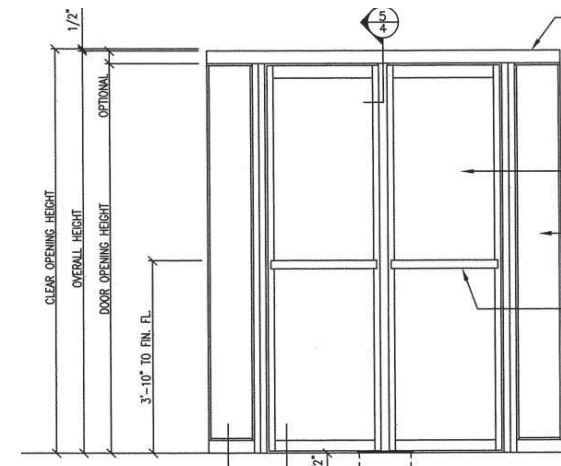

UNMATCHED AESTHETICS

Our patented door wing collapsing mechanism and bearing is concealed below the floor and within the canopy ceiling, so the stile to rail connection is crisp and clean.



AUTOMATIC SWING DOOR OPERATORS

HEAVY DUTY, LOW ENERGY AND FULLY AUTOMATIC: M-FORCE™

DIFFERENTIATION: Can be tuned to full or low energy operation. Includes the iQ Controller, which is able to intelligently respond to manual and automatic opening methods and integrate easily with third party systems. Allows for field adjustments to work as both full energy (motion activated) or low energy (knowing act activated) automation and has the ability to compensate for wind and stack pressure. Can be surface mounted, overhead concealed or bottom loaded.

SWING DOOR PANELS: Up to 48"

DOOR PANEL WEIGHT: Up to 700 pounds

MORE INFORMATION: stanleyaccess.com/m-force



HEAVY DUTY FULL AUTOMATIC: MAGIC SWING

DIFFERENTIATION: Full energy solution. Can withstand extreme environments, wind and stack pressure conditions, and abuse while maintaining smooth and controlled operation. Surface mount or overhead concealed. Not a low energy solution.

SWING DOOR PANELS: Up to 54"

DOOR PANEL WEIGHT: Up to 700 pounds

MORE INFORMATION: stanleyaccess.com/magic-swing

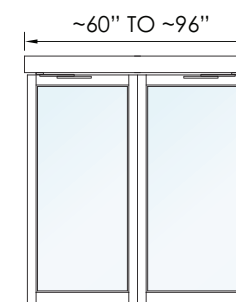

PAIR

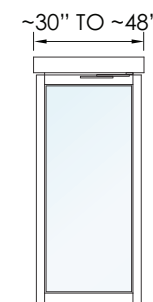

SINGLE



INTERIOR



MANUAL SLIDING DOORS WITH BREAKAWAY

APPLICATIONS

- › ICU/CCUs
- › Pressurized Isolation Rooms
- › Smoke Rated Rooms
- › Emergency Treatment Rooms
- › Pre/Post Rooms
- › Same Day Surgery Rooms
- › Trauma Rooms
- › Large Office/Meeting Rooms
- › Cath Lab Equipment Rooms
- › Triage
- › Room Dividers

CONFIGURATIONS

- › 2-, 3-, 4-, 6- and P-Panel designs
- › Privacy Glass
- › Automatic and Manual Models
- › Trackless
- › Code Compliant and Specialty Rated



MORE INFORMATION:

stanleyaccess.com/all-manual-icu-ccu-door-products

DURA-CARE 7500TL-FBO

DIFFERENTIATION: Specifically designed to meet demands for patient and equipment transport. Our 7500 TL-FBO has the largest clear door opening* in our portfolio with an 8' package at 52.6".

AVAILABLE IN: Automatic with touchless activation for infection control

MORE INFORMATION: stanleyaccess.com/duracare-7500series

*without positive latch

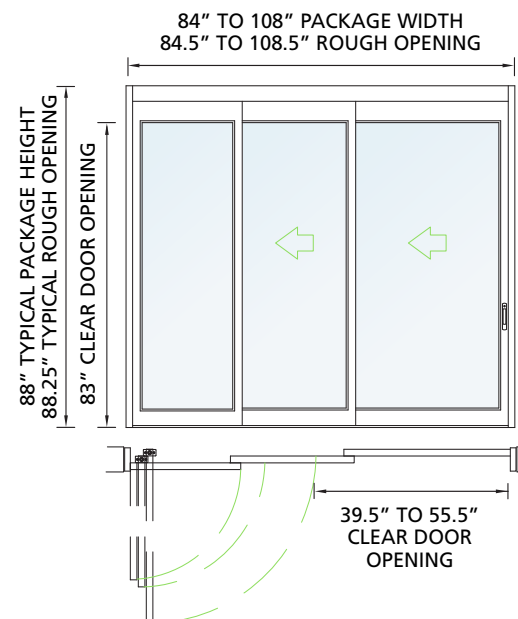

THE PROCARE DIFFERENCE

The industry's only human-centric ICU doors deliberately designed with respect for patients and caregivers in sensitive healthcare environments.



Protect the Patient



Eliminate dangerous snagging of IV lines and equipment during patient transport.

Wide clear door opening including the widest of any 2-panel in the industry.



Promote Healing



Easy and more controlled breakaway and return with our new instant swing out button.

Quiet and flawless operation every time with our swing out guidance system.



Manual Slide Trackless 2-Panel

PROCARE 8300

DIFFERENTIATION: Loaded with STANLEY exclusive features including a Swing Out Button, Swing Out Guidance System and Catch Free Contoured Handle, this 2-panel door has the widest clear door opening of any in the industry. These features allow patient transport and care to be the focus.

AVAILABLE IN: automatic with touchless activation for infection control

MORE INFORMATION: stanleyaccess.com/procare-8300

RATINGS*: Smoke & Draft, Infection Control, STC



** The typical ProCare 8300 configuration complies with the Buy American Act

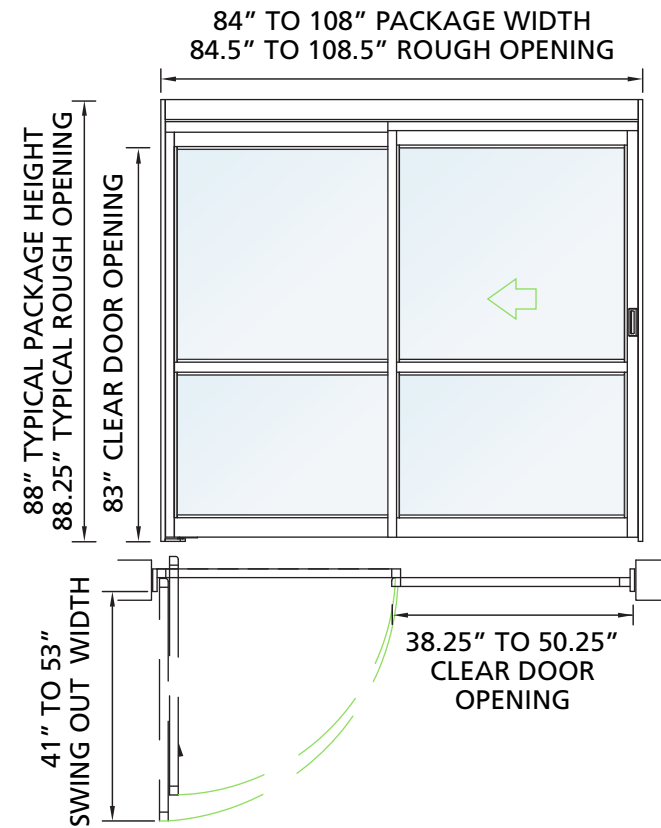

STANDARD FEATURES

- Swing Out Button (STANLEY Exclusive)
- Swing Out Guidance System (STANLEY Exclusive)
- Catch Free Contoured Handle (STANLEY exclusive)

* Restrictions may apply such as overall frame height, sliding/breakaway panel width and glazing.

** as specified in Section 52.225-1 and Section 52.225.11 of the Federal Acquisition Regulations as of August, 2017.

*** sidelite provided by a 3rd party

4-Panel Compact Bi-Part

PROCARE 8300BP

DIFFERENTIATION: The **space-optimizing ICU door solution**, this compact 4-panel bi-part is the newest alternative to the standard ICU door. With a smaller breakaway arc, you can meet NFPA corridor codes and **never have to give up a square inch of your patient room design**. Effortless **one-handed operation** slides both center panels simultaneously. Our exclusive soft open/close **prevents loud slamming** and extends the life of the door.

RATINGS*: Smoke & Draft, Infection control

MORE INFORMATION: stanleyaccess.com/procare-8300bp

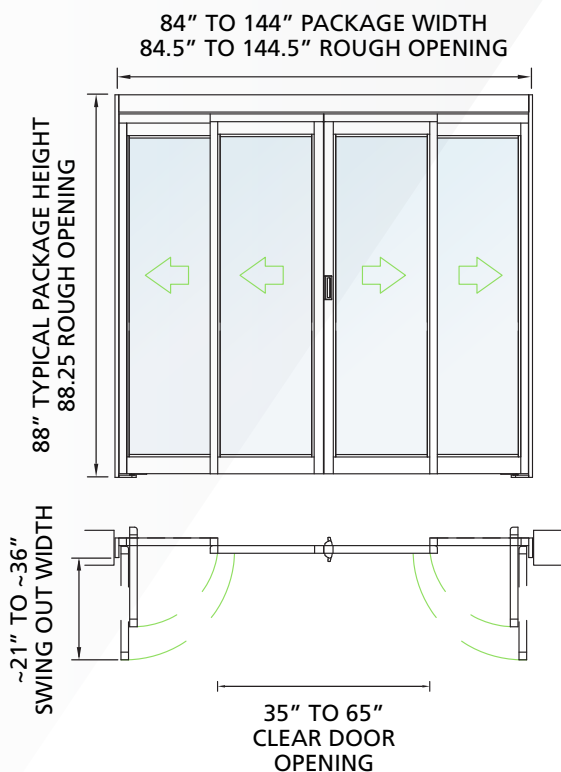

STANDARD FEATURES

- Swing Out Button (STANLEY Exclusive)
- Swing Out Guidance System (STANLEY Exclusive)
- Catch Free Contoured Handle (STANLEY Exclusive)
- Soft Open / Close (STANLEY Exclusive)

* Restrictions may apply such as overall frame height, sliding/breakaway panel width and glazing.

SWING AND SWING/FOLD DOORS

MANUAL SWING: DURA-CARE 7400



SWING: 7400 Series single, pair or uneven pair configurations with a heavy-duty continuous hinge and built-in concealed closer. ANSI/UL 1784 for Leakage Rated Door Assemblies: ("Smoke and Draft").

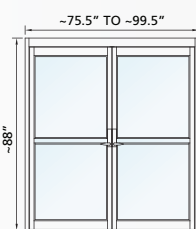
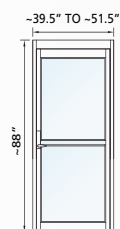

MORE INFORMATION: stanleyaccess.com/manual-icu-ccu-swing

AUTOMATIC SWING DOOR OPERATOR: M-FORCE™

DIFFERENTIATION: Performance that isn't measured in years, but decades. Allows for maximum flexibility at design phase and upon installation because it is field adjustable to work as both full energy (motion activated) or low energy (knowing act activated) automation. Can be surface mounted, overhead concealed or bottom loaded. Available as a fire door package with UL listed equipment for applications such as hospitals.

SWING DOOR PANELS: Up to 48"

DETAILED INFORMATION: stanleyaccess.com/m-force

HYBRID SWING/FOLD: DURA-CARE 7600

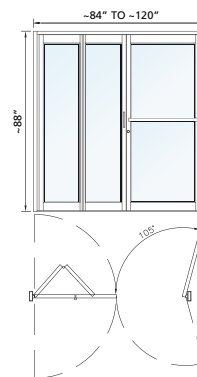

DIFFERENTIATION: 7600 Series combines a bidirectional manual swing door with a two-panel manual bi-fold door in one continuous header.

MORE INFORMATION: stanleyaccess.com/hybrid-swing-fold



AUTOMATIC SLIDERS FOR INTERIOR APPLICATIONS

AUTOMATIC SLIDING DOOR OPERATORS



 Bristol Myers Squibb
**Fiberglass Reinforced
 Plastic Door Leafs**
 TLB Architecture, LLC

Slide Door Operators are comprised of an operator with a header and hanger that the door panels attach to. Most commonly surface mounted, slide door operators are available for projects that require options beyond standard aluminum and glass panels. This offering gives architects the ability to use custom door materials such as metal, wood, hollow-metal or FRP (Fiberglass Reinforced Plastic). Panels and panel preparation are generally provided by a third party.

The Dura-Glide Designer Package comes in a bi-part or single slide configuration with customizable sizes.

MORE INFORMATION:

stanleyaccess.com/slide-door-operators

AUTOMATIC TELESCOPING SLIDING DOORS



Gift Shop: **Dura-Glide 5300**



Specialty patient rooms: **DuraFit**

STANLEY[®]

Access Technologies

CONTACT

StanleyAccess.com

1-800-7-ACCESS

Service: 1-888-DOOR-444

MAKE THE

WORLD

ACCESSIBLE