

**STANLEY**  
Access Technologies

# DURA-GLIDE 5200 SERIES

6-PANEL TELESCOPIC WITH OPTIONAL TRANSOM

PROJECT INFORMATION

PROJECT NAME:

LOCATION:

DOOR NUMBER(S):

DATE:

SHEET: OF

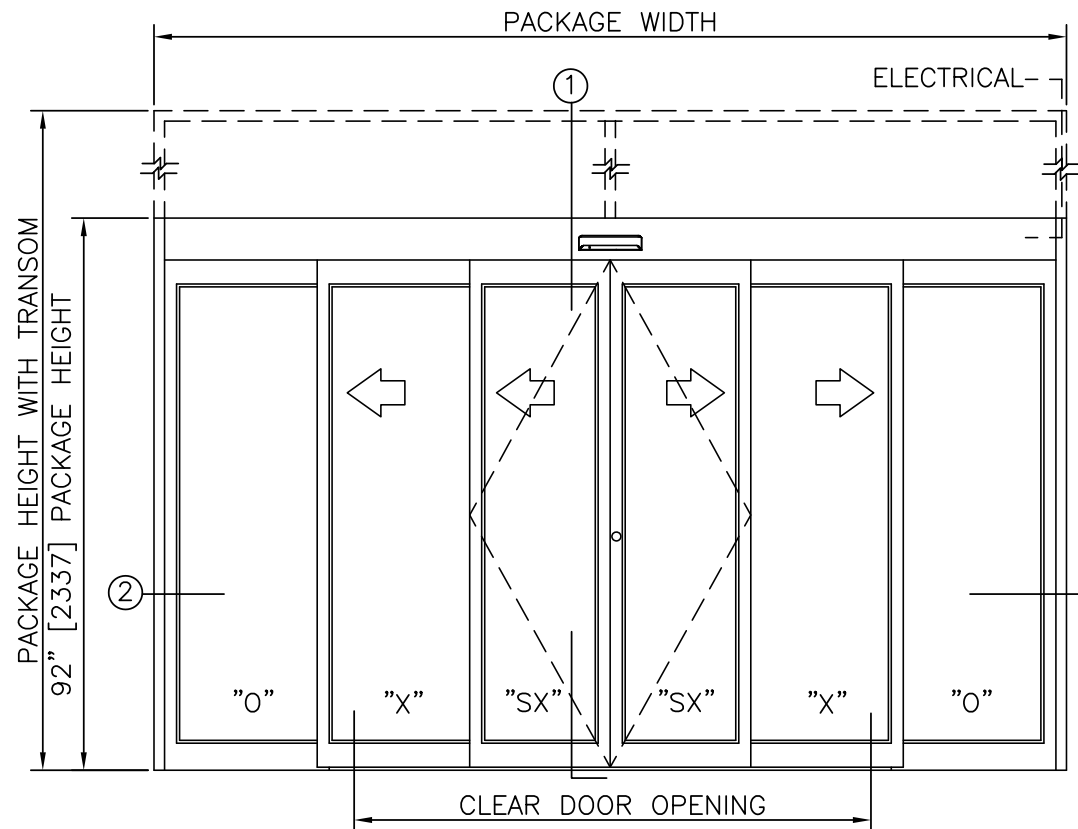

**ELEVATION VIEW**  
SCALE: 3/8" = 1'-0"

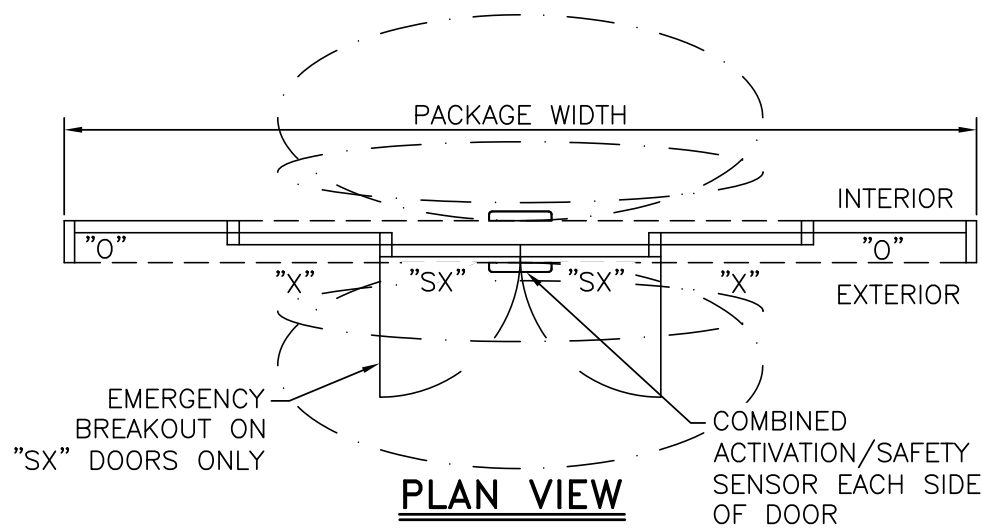

**PLAN VIEW**  
SCALE: 3/8" = 1'-0"

**NOTES**

1. ELECTRICAL REQUIREMENTS: 120 VAC, 5 AMP MIN TO POWER OPERATOR BY ELECTRICAL CONTRACTOR.
2. ROUGH OPENING SHALL PROVIDE 1/4"[6] SHIM SPACE ON SIDES AND TOP OF PACKAGE.
3. LIMITS OF ACTIVATION AND SAFETY ZONES ARE FOR REFERENCE ONLY; SEE ANSI/BHMA A156.10 FOR DETAILED REQUIREMENTS.
4. STANDARD LOCKING IS 2-POINT; 3-POINT AND ACCESS CONTROL SYSTEMS AVAILABLE. SEE SHEET 1.61.
5. STANDARD GLAZING STOPS FOR SLIDING AND FIXED PANELS ARE 1/4"[6]; 5/8"[16] AND 1"[25] AVAILABLE.
6. STANDARD STILES AND BOTTOM RAILS SHOWN; MEDIUM STILES, BOTTOM RAILS TO 12"[305], AND MUNTINS AVAILABLE.
7. SEE SPECIFICATIONS FOR ADDITIONAL INFORMATION.

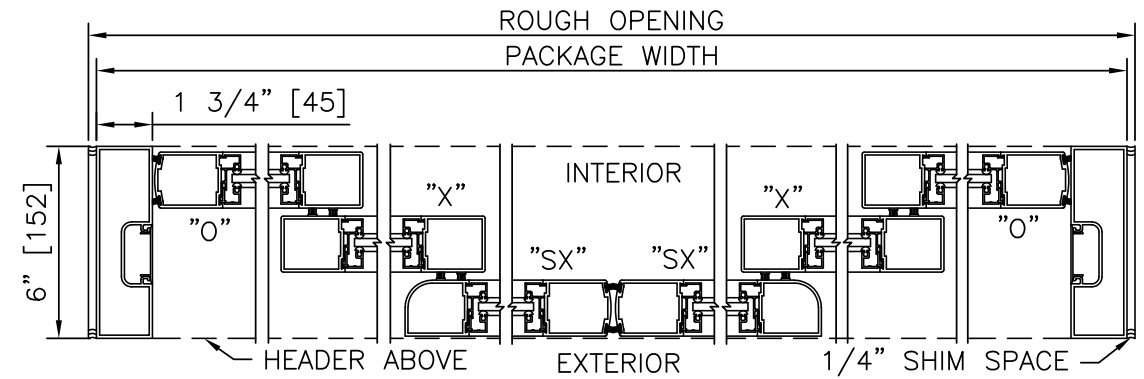

**2 HORIZONTAL SECTION**  
SCALE: 2" = 1'-0"

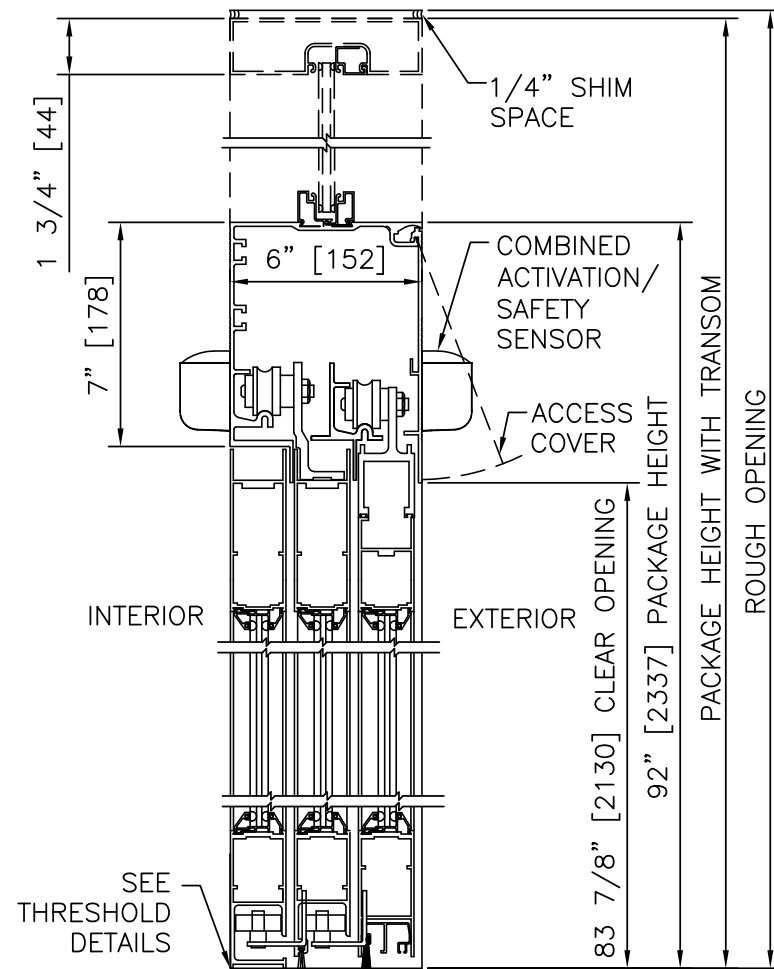

**1 VERTICAL SECTION**  
SCALE: 2" = 1'-0"

**PRODUCT OPTIONS**

- TRANSOM
  - YES
  - VERTICALS 1 2 3 4 5
- FINISH
  - ANODIZED CLEAR CL2
  - ANODIZED DK BRONZE
  - CUSTOM
- LOCKING
  - 2-POINT
  - 3-POINT
  - ACCESS CONTROL (PANIC)
- STILES
  - NARROW
  - MEDIUM
- BOTTOM RAILS
  - STANDARD 4"
  - OPTIONAL 6" 8" 10" 12"
- THRESHOLDS
  - NONE
  - RECESSED
  - DBL BVL
- ACTIVATION/SAFETY
  - 2 COMBINED ACTIVATION/SAFETY SENSORS
- OTHER OPTIONS
  - ROTARY CTRL SWITCH
  - KEYED
  - UNINTERRUPTIBLE POWER SUPPLY
  - FLY OPEN BOX
  - ALARM CONTACTS
  - CLEAN ROOM (CL 10)

**6-PANEL TELESCOPIC FORMULAS - NARROW STILE**  
 PACKAGE WIDTH = 3/2 CLEAR DOOR OPENING + 30.7"  
 CLEAR DOOR OPENING = 2/3 PACKAGE WIDTH - 20.5"  
 EMERGENCY BREAKOUT WIDTH = 2 X DOOR PANEL WIDTH - 5.1"  
 DOOR PANEL WIDTH (SX, O) = 1/6 PACKAGE WIDTH + 1.1"  
 DOOR PANEL WIDTH (X) = 1/6 PACKAGE WIDTH + 1.0"

**6-PANEL TELESCOPIC FORMULAS - MEDIUM STILE**  
 PACKAGE WIDTH = 3/2 CLEAR DOOR OPENING + 42.7"  
 CLEAR DOOR OPENING = 2/3 PACKAGE WIDTH - 28.5"  
 EMERGENCY BREAKOUT WIDTH = 2 X DOOR PANEL WIDTH - 8.3"  
 DOOR PANEL WIDTH (ALL) = 1/6 PACKAGE WIDTH + 2.1"

TYPICAL PACKAGE DIMENSIONS (NARROW STILE)			
PACKAGE WIDTH	NOMINAL CLEAR DOOR OPENING	SLIDING DOOR PANEL NOMINAL WIDTH	EMERGENCY BREAKOUT NOM. WIDTH
120"	59.5"	21.0"	37.1"
144"	75.5"	25.0"	45.1"
168"	91.5"	29.0"	53.1"

6-PANEL TELESCOPIC WITH OPTIONAL TRANSOM

# DURA-GLIDE 5200 SERIES

**STANLEY**  
Access Technologies

**DURA-GLIDE  
5200  
SERIES**

6-PANEL TELESCOPIC

PROJECT INFORMATION

PROJECT NAME:

LOCATION:

DOOR NUMBER(S):

DATE:

SHEET: OF

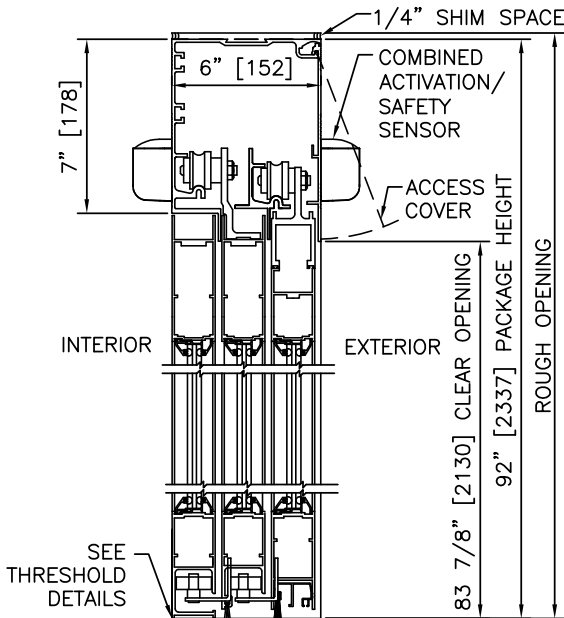

① VERTICAL SECTION

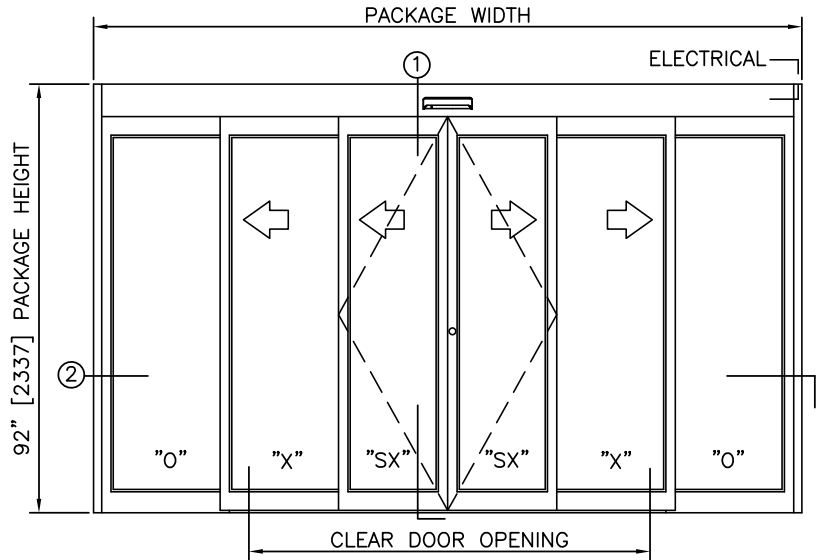

ELEVATION

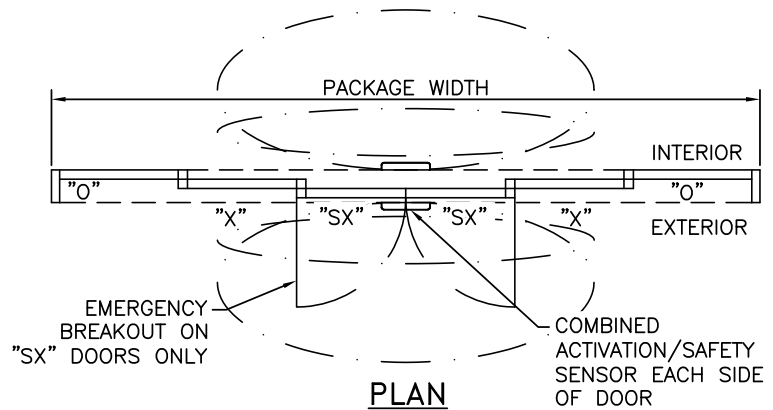

PLAN

NOTES

1. ELECTRICAL REQUIREMENTS: 120 VAC, 5 AMP MIN TO POWER OPERATOR BY ELECTRICAL CONTRACTOR.
2. ROUGH OPENING SHALL PROVIDE 1/4" [6] SHIM SPACE ON SIDES AND TOP OF PACKAGE.
3. LIMITS OF ACTIVATION AND SAFETY ZONES ARE FOR REFERENCE ONLY; SEE ANSI/BHMA A156.10 FOR DETAILED REQUIREMENTS.
4. SEE SPECIFICATIONS FOR ADDITIONAL INFORMATION.

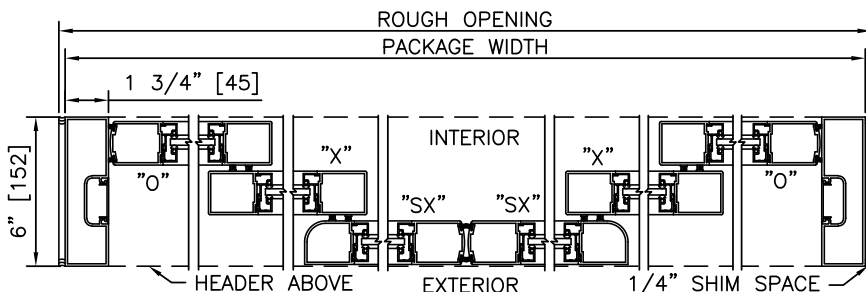

② HORIZONTAL SECTION

TYPICAL PACKAGE DIMENSIONS (NARROW STILE)

PACKAGE WIDTH	NOMINAL CLEAR DOOR OPENING	SLIDING DOOR PANEL NOMINAL WIDTH	EMERGENCY BREAKOUT NOM. WIDTH
120"	59.5"	21.0"	37.1"
144"	75.5"	25.0"	45.1"
168"	91.5"	29.0"	53.1"

**DURA-GLIDE  
5200  
SERIES**

6-PANEL TELESCOPIC WITH TRANSOM

PROJECT INFORMATION

PROJECT NAME:

LOCATION:

DOOR NUMBER(S):

DATE:

SHEET: OF

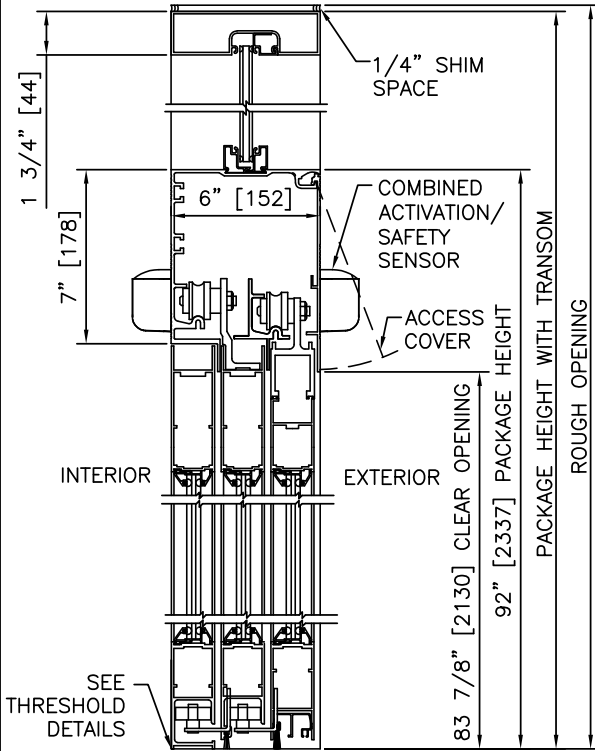

① VERTICAL SECTION

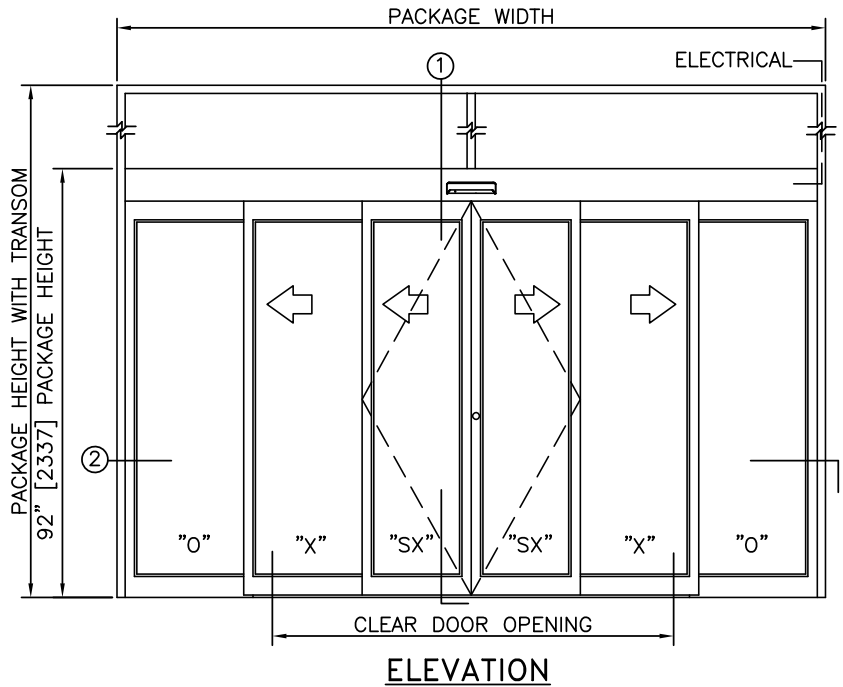

ELEVATION

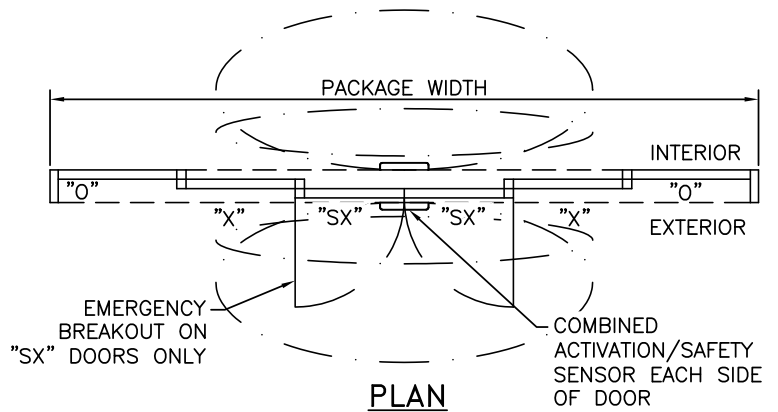

PLAN

NOTES

1. ELECTRICAL REQUIREMENTS: 120 VAC, 5 AMP MIN TO POWER OPERATOR BY ELECTRICAL CONTRACTOR.
2. ROUGH OPENING SHALL PROVIDE 1/4\"[6] SHIM SPACE ON SIDES AND TOP OF PACKAGE.
3. LIMITS OF ACTIVATION AND SAFETY ZONES ARE FOR REFERENCE ONLY; SEE ANSI/BHMA A156.10 FOR DETAILED REQUIREMENTS.
4. SEE SPECIFICATIONS FOR ADDITIONAL INFORMATION.

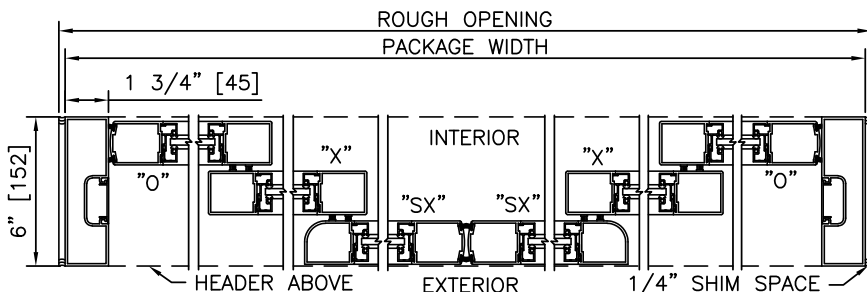

② HORIZONTAL SECTION

TYPICAL PACKAGE DIMENSIONS (NARROW STILE)

PACKAGE WIDTH	NOMINAL CLEAR DOOR OPENING	SLIDING DOOR PANEL NOMINAL WIDTH	EMERGENCY BREAKOUT NOM. WIDTH
120"	59.5"	21.0"	37.1"
144"	75.5"	25.0"	45.1"
168"	91.5"	29.0"	53.1"

**DURA-GLIDE  
5200  
SERIES**

6-PANEL TELESCOPIC WITH ACCESS CONTROL, SURFACE

PROJECT INFORMATION

PROJECT NAME:

LOCATION:

DOOR NUMBER(S):

DATE:

SHEET: OF

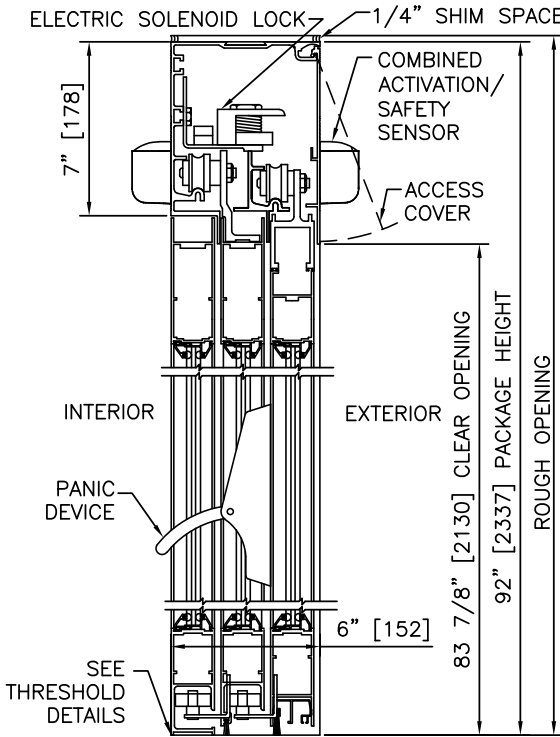

1 VERTICAL SECTION

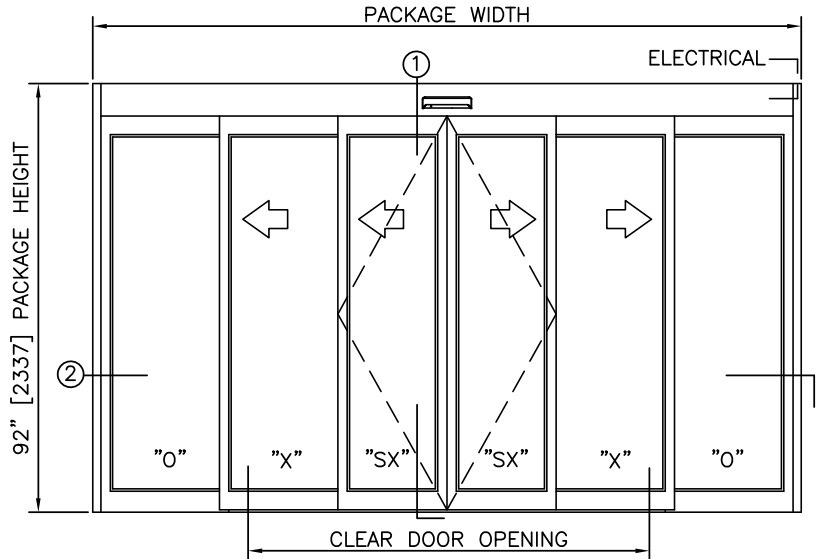

ELEVATION

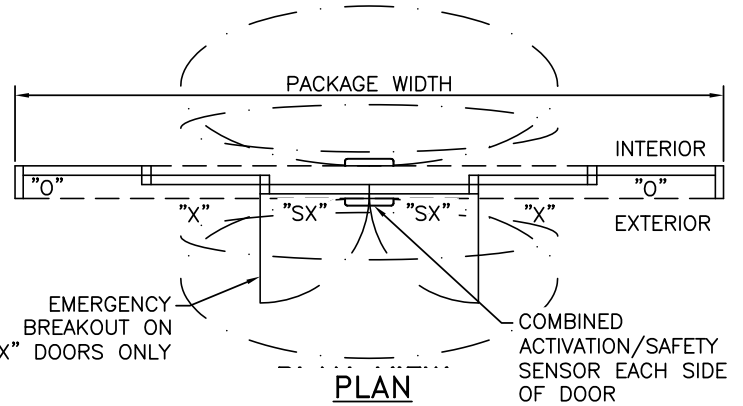

PLAN

**NOTES**

1. ELECTRICAL REQUIREMENTS: BY ELECTRICAL CONTRACTOR 120 VAC, 5 AMP MIN TO POWER OPERATOR CONTROL CIRCUIT FROM SECURE ACTIVATION TO OPERATOR
2. ROUGH OPENING SHALL PROVIDE 1/4"[6] SHIM SPACE ON SIDES AND TOP OF PACKAGE.
3. LIMITS OF ACTIVATION AND SAFETY ZONES ARE FOR REFERENCE ONLY; SEE ANSI/BHMA A156.10 FOR DETAILED REQUIREMENTS.
4. SEE SPECIFICATIONS FOR ADDITIONAL INFORMATION.

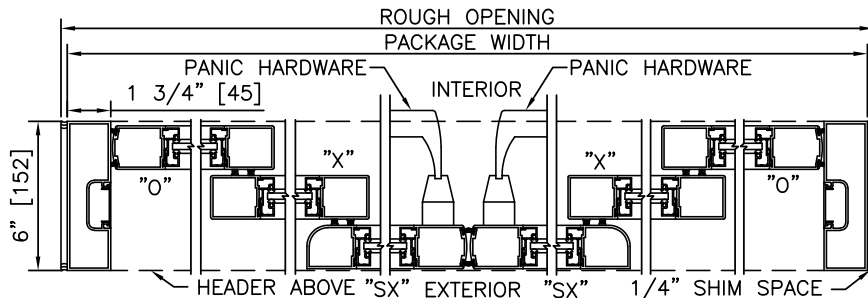

2 HORIZONTAL SECTION

TYPICAL PACKAGE DIMENSIONS (NARROW STILE)

PACKAGE WIDTH	NOMINAL CLEAR DOOR OPENING	SLIDING DOOR PANEL NOMINAL WIDTH	EMERGENCY BREAKOUT NOM. WIDTH
120"	59.5"	21.0"	37.1"
144"	75.5"	25.0"	45.1"
168"	91.5"	29.0"	53.1"

**DURA-GLIDE  
5200  
SERIES**

6-PANEL TELESCOPIC WITH TRANSOM & ACCESS CONTROL, SURFACE

PROJECT INFORMATION

PROJECT NAME:

LOCATION:

DOOR NUMBER(S):

DATE:

SHEET: OF

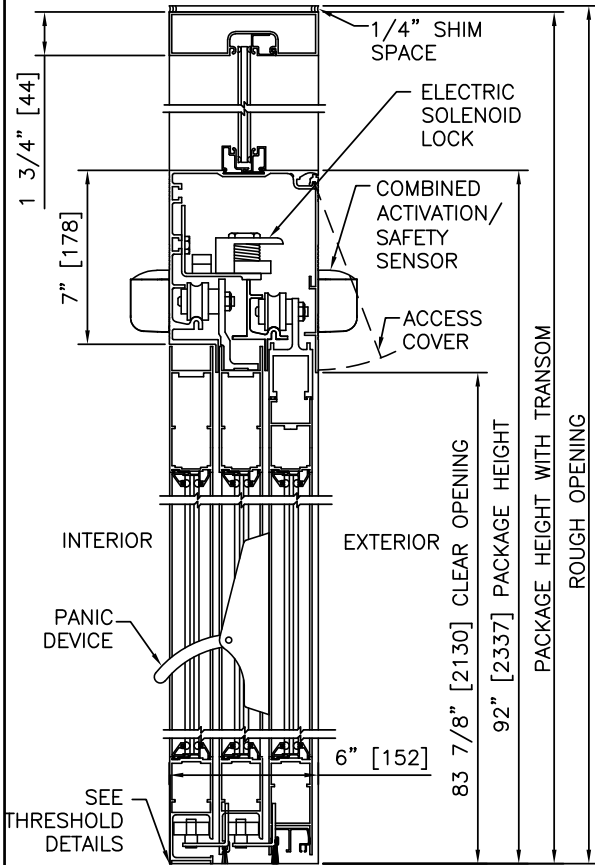

1 VERTICAL SECTION

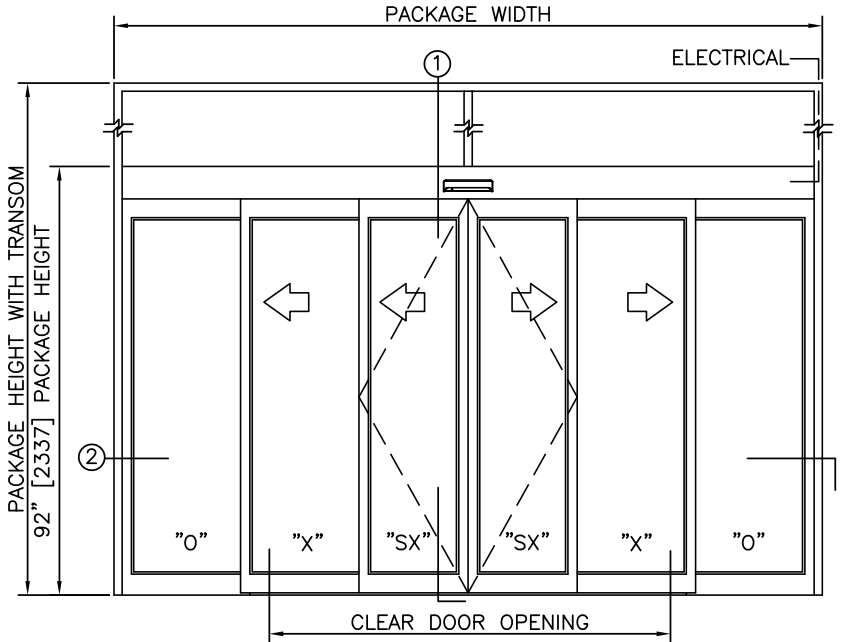

ELEVATION

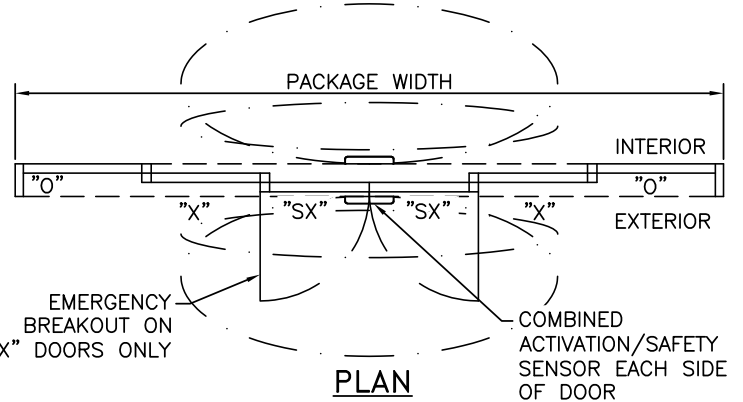

NOTES

- ELECTRICAL REQUIREMENTS: BY ELECTRICAL CONTRACTOR 120 VAC, 5 AMP MIN TO POWER OPERATOR CONTROL CIRCUIT FROM SECURE ACTIVATION TO OPERATOR
- ROUGH OPENING SHALL PROVIDE 1/4"[6] SHIM SPACE ON SIDES AND TOP OF PACKAGE.
- LIMITS OF ACTIVATION AND SAFETY ZONES ARE FOR REFERENCE ONLY; SEE ANSI/BHMA A156.10 FOR DETAILED REQUIREMENTS.
- SEE SPECIFICATIONS FOR ADDITIONAL INFORMATION.

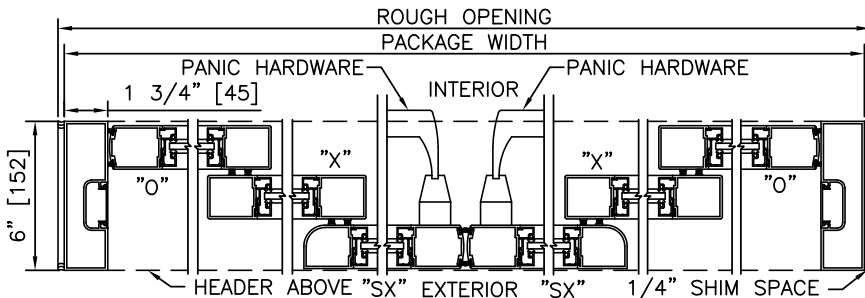

2 HORIZONTAL SECTION

TYPICAL PACKAGE DIMENSIONS (NARROW STILE)

PACKAGE WIDTH	NOMINAL CLEAR DOOR OPENING	SLIDING DOOR PANEL NOMINAL WIDTH	EMERGENCY BREAKOUT NOM. WIDTH
120"	59.5"	21.0"	37.1"
144"	75.5"	25.0"	45.1"
168"	91.5"	29.0"	53.1"

**DURA-GLIDE  
5200  
SERIES**

6-PANEL TELESCOPIC WITH ACCESS CONTROL, RECESSED

PROJECT INFORMATION

PROJECT NAME:

LOCATION:

DOOR NUMBER(S):

DATE:

SHEET: OF

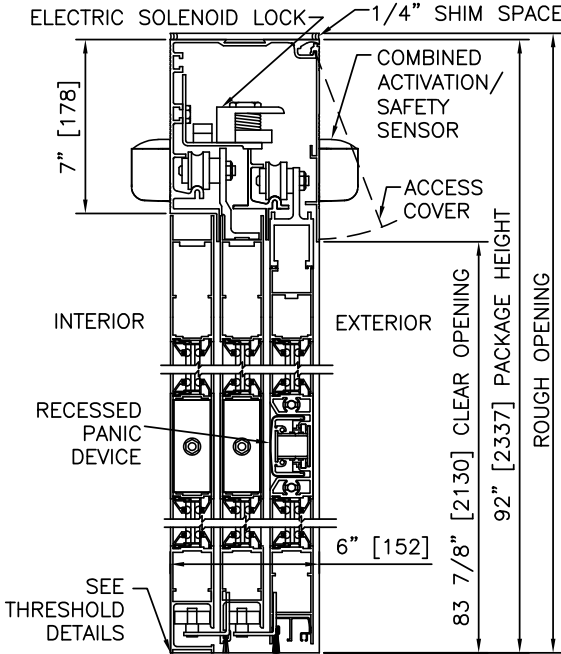

① VERTICAL SECTION

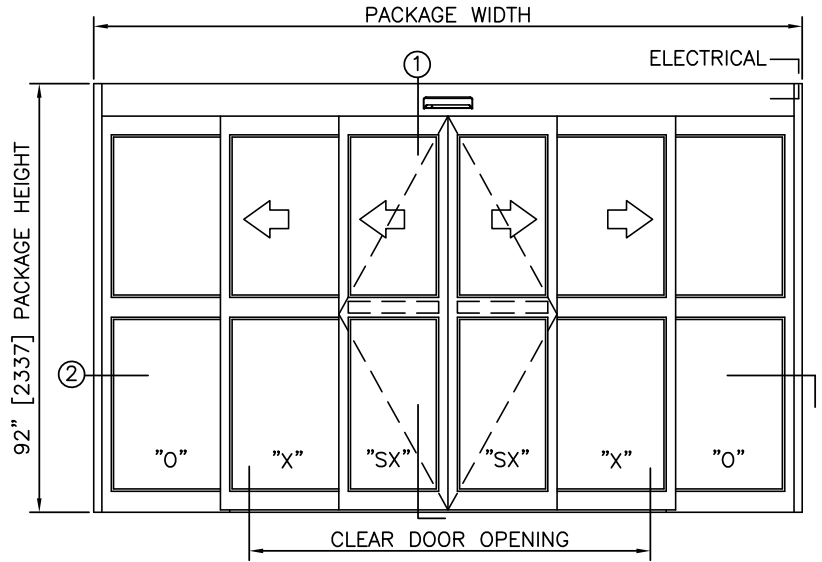

ELEVATION

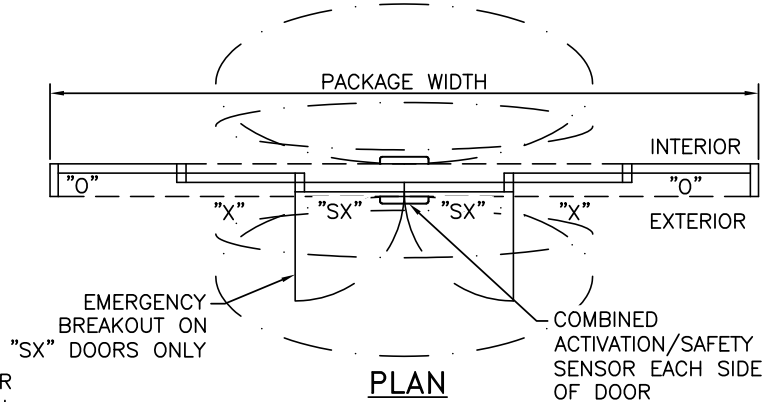

PLAN

**NOTES**

1. ELECTRICAL REQUIREMENTS: BY ELECTRICAL CONTRACTOR  
120 VAC, 5 AMP MIN TO POWER OPERATOR  
CONTROL CIRCUIT FROM SECURE ACTIVATION TO OPERATOR
2. ROUGH OPENING SHALL PROVIDE 1/4" [6] SHIM SPACE ON SIDES AND TOP OF PACKAGE.
3. LIMITS OF ACTIVATION AND SAFETY ZONES ARE FOR REFERENCE ONLY; SEE ANSI/BHMA A156.10 FOR DETAILED REQUIREMENTS.
4. SEE SPECIFICATIONS FOR ADDITIONAL INFORMATION.

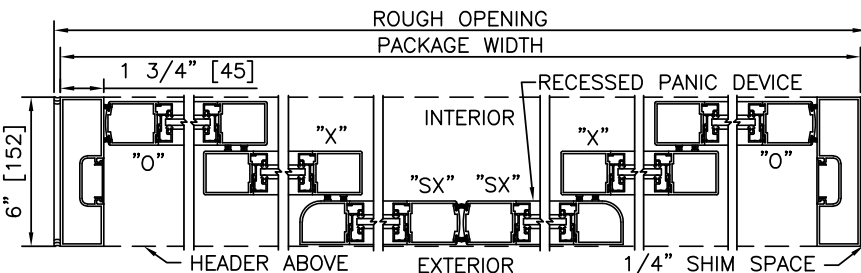

② HORIZONTAL SECTION

TYPICAL PACKAGE DIMENSIONS (NARROW STILE)

PACKAGE WIDTH	NOMINAL CLEAR DOOR OPENING	SLIDING DOOR PANEL NOMINAL WIDTH	EMERGENCY BREAKOUT NOM. WIDTH
120"	59.5"	21.0"	37.1"
144"	75.5"	25.0"	45.1"
168"	91.5"	29.0"	53.1"

**DURA-GLIDE  
5200  
SERIES**

6-PANEL TELESCOPIC WITH TRANSOM & ACCESS CONTROL, RECESSED

PROJECT INFORMATION

PROJECT NAME:

LOCATION:

DOOR NUMBER(S):

DATE:

SHEET: OF

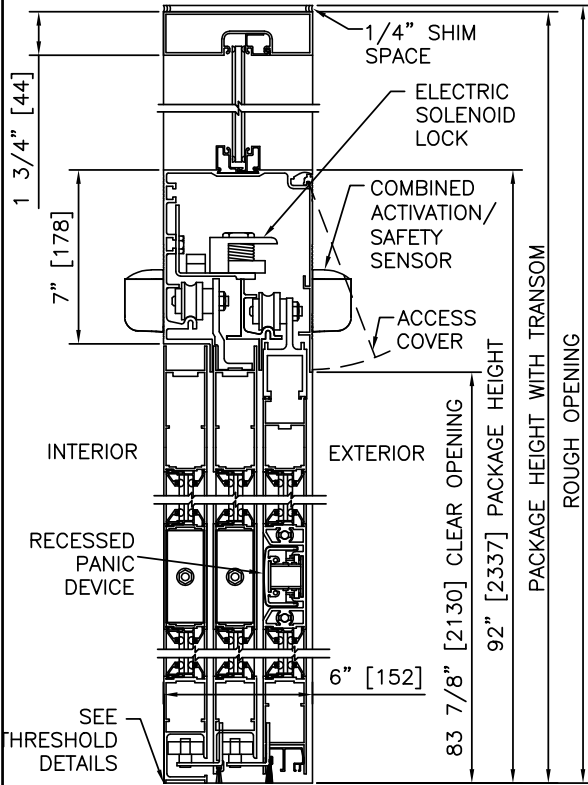

1 VERTICAL SECTION

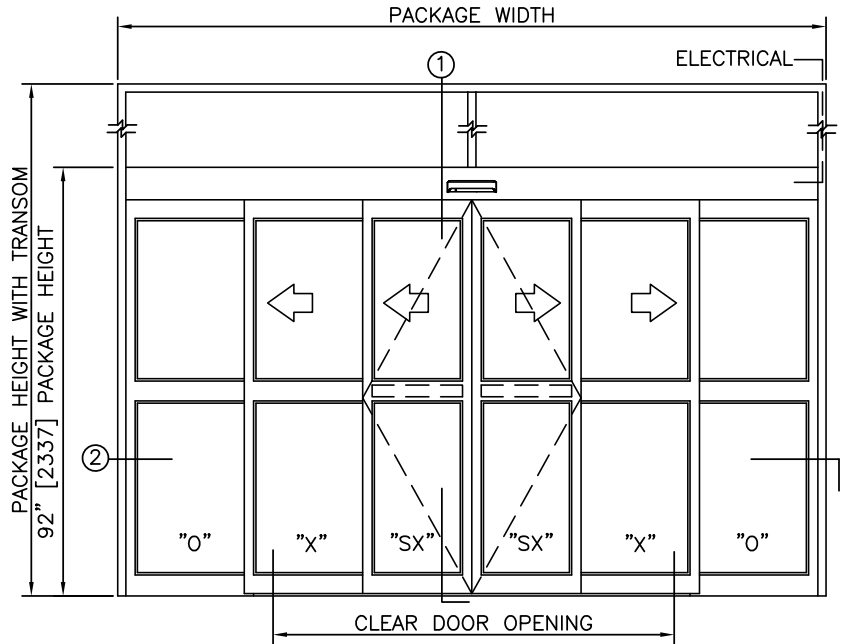

ELEVATION

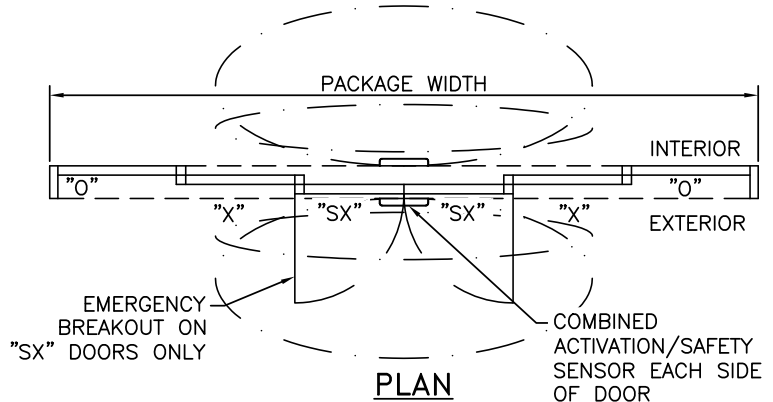

PLAN

**NOTES**

1. ELECTRICAL REQUIREMENTS: BY ELECTRICAL CONTRACTOR 120 VAC, 5 AMP MIN TO POWER OPERATOR CONTROL CIRCUIT FROM SECURE ACTIVATION TO OPERATOR
2. ROUGH OPENING SHALL PROVIDE 1/4" [6] SHIM SPACE ON SIDES AND TOP OF PACKAGE.
3. LIMITS OF ACTIVATION AND SAFETY ZONES ARE FOR REFERENCE ONLY; SEE ANSI/BHMA A156.10 FOR DETAILED REQUIREMENTS.
4. SEE SPECIFICATIONS FOR ADDITIONAL INFORMATION.

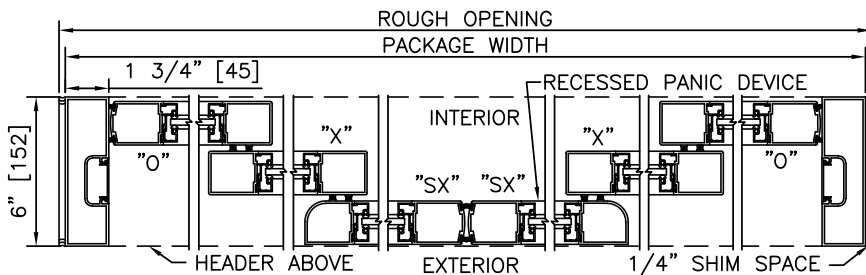

2 HORIZONTAL SECTION

TYPICAL PACKAGE DIMENSIONS (NARROW STILE)

PACKAGE WIDTH	NOMINAL CLEAR DOOR OPENING	SLIDING DOOR PANEL NOMINAL WIDTH	EMERGENCY BREAKOUT NOM. WIDTH
120"	59.5"	21.0"	37.1"
144"	75.5"	25.0"	45.1"
168"	91.5"	29.0"	53.1"

**DURA-GLIDE  
5200  
SERIES**

6-PANEL TELESCOPIC, SURFACE APPLIED

PROJECT INFORMATION

PROJECT NAME:

LOCATION:

DOOR NUMBER(S):

DATE:

SHEET: OF

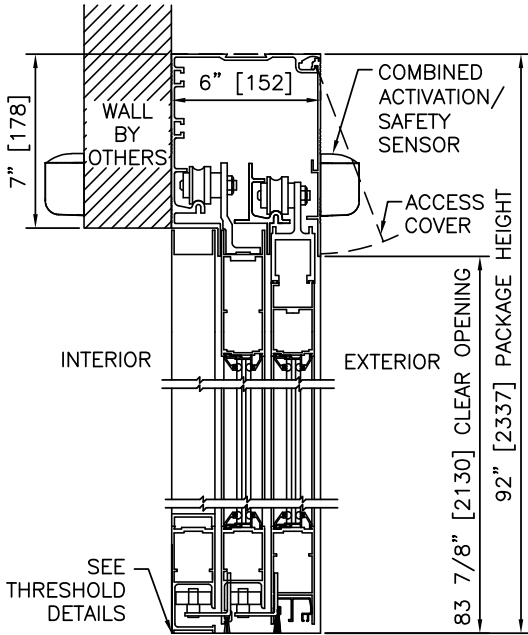

① VERTICAL SECTION

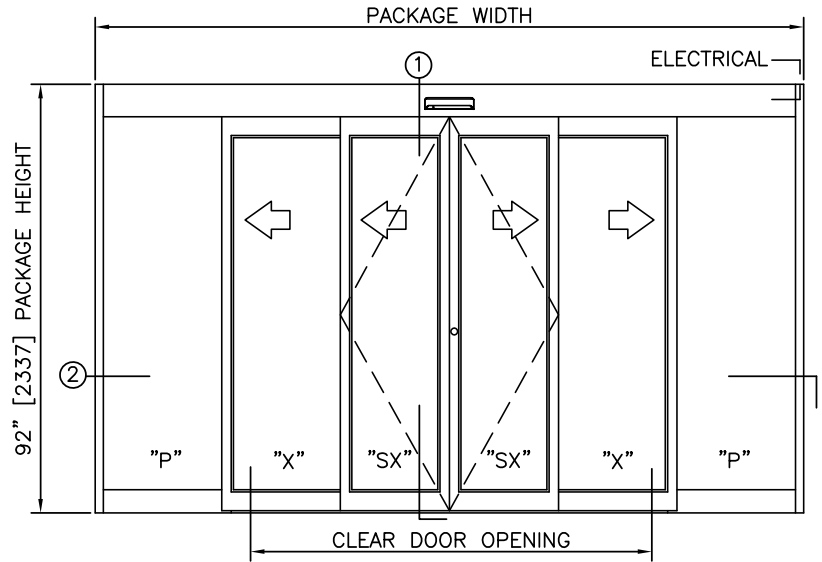

ELEVATION

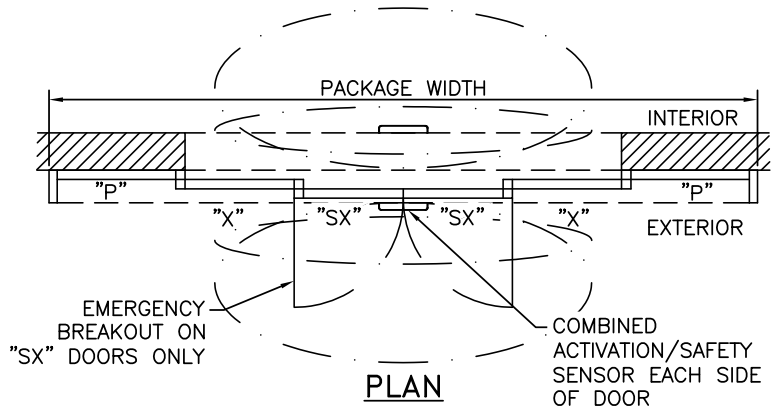

PLAN

**NOTES**

1. ELECTRICAL REQUIREMENTS: 120 VAC, 5 AMP MIN TO POWER OPERATOR BY ELECTRICAL CONTRACTOR.
2. LIMITS OF ACTIVATION AND SAFETY ZONES ARE FOR REFERENCE ONLY; SEE ANSI/BHMA A156.10 FOR DETAILED REQUIREMENTS.
3. SEE SPECIFICATIONS FOR ADDITIONAL INFORMATION.

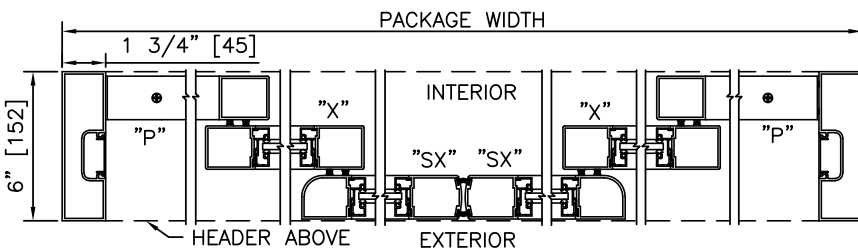

② HORIZONTAL SECTION

TYPICAL PACKAGE DIMENSIONS (NARROW STILE)

PACKAGE WIDTH	NOMINAL CLEAR DOOR OPENING	SLIDING DOOR PANEL NOMINAL WIDTH	EMERGENCY BREAKOUT NOM. WIDTH
120"	59.5"	21.0"	37.1"
144"	75.5"	25.0"	45.1"
168"	91.5"	29.0"	53.1"



**DURA-GLIDE  
5200  
SERIES**

6-PANEL TELESCOPIC WITH ACCESS CONTROL, RECESSED, SURFACE APPLIED

PROJECT INFORMATION

PROJECT NAME:

LOCATION:

DOOR NUMBER(S):

DATE:

SHEET: OF

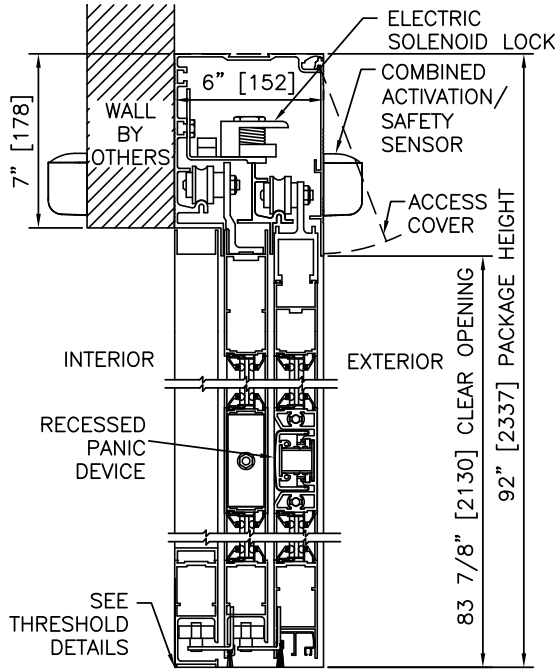

① VERTICAL SECTION

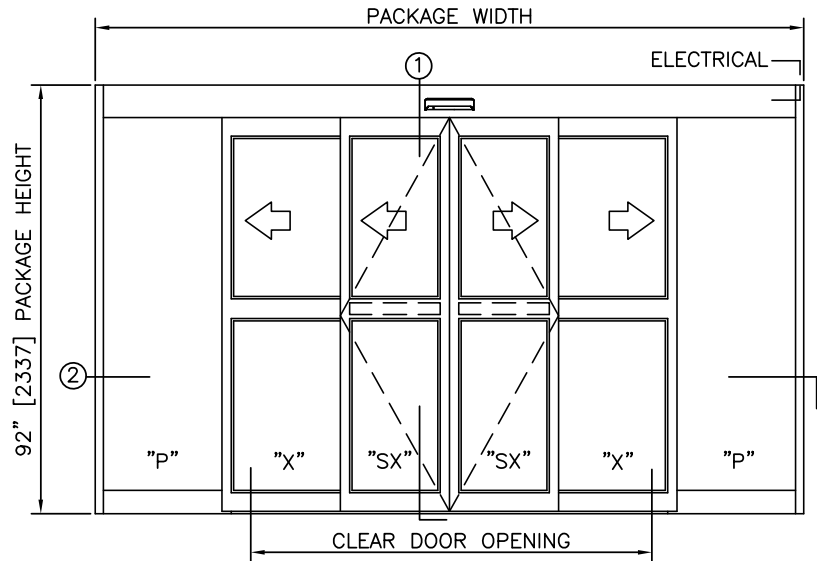

ELEVATION

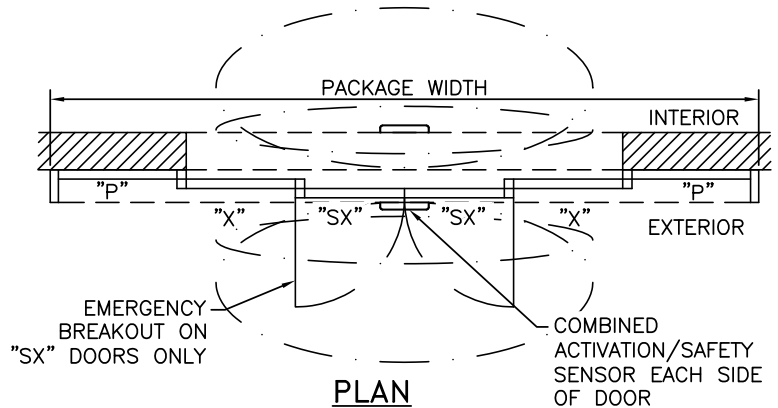

PLAN

**NOTES**

1. ELECTRICAL REQUIREMENTS: BY ELECTRICAL CONTRACTOR  
120 VAC, 5 AMP MIN TO POWER OPERATOR  
CONTROL CIRCUIT FROM SECURE ACTIVATION TO OPERATOR
2. LIMITS OF ACTIVATION AND SAFETY ZONES ARE FOR  
REFERENCE ONLY; SEE ANSI/BHMA A156.10 FOR DETAILED  
REQUIREMENTS.
3. SEE SPECIFICATIONS FOR ADDITIONAL INFORMATION.

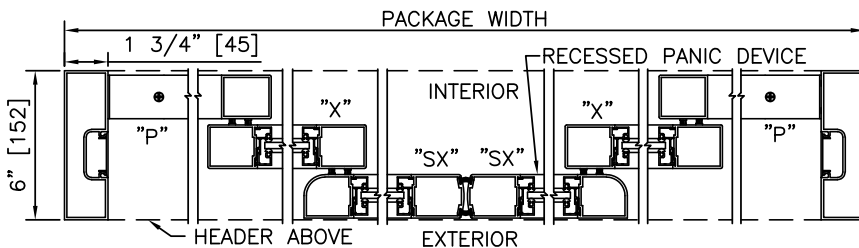

② HORIZONTAL SECTION

TYPICAL PACKAGE DIMENSIONS (NARROW STILE)

PACKAGE WIDTH	NOMINAL CLEAR DOOR OPENING	SLIDING DOOR PANEL NOMINAL WIDTH	EMERGENCY BREAKOUT NOM. WIDTH
120"	59.5"	21.0"	37.1"
144"	75.5"	25.0"	45.1"
168"	91.5"	29.0"	53.1"